



Electric stand-on/sideways-seated pallet truck

ESE 430

Lift height: 115 mm / Load capacity: 3000 kg

JUNGHEINRICH

ESE 430

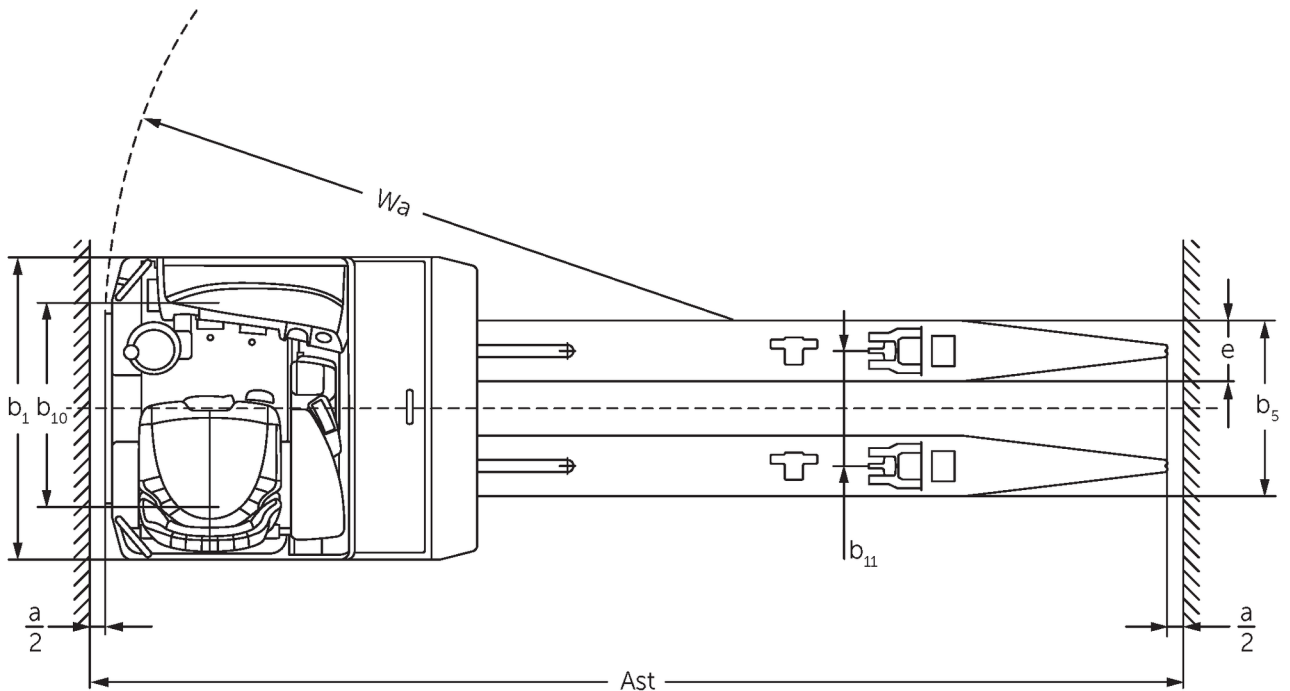
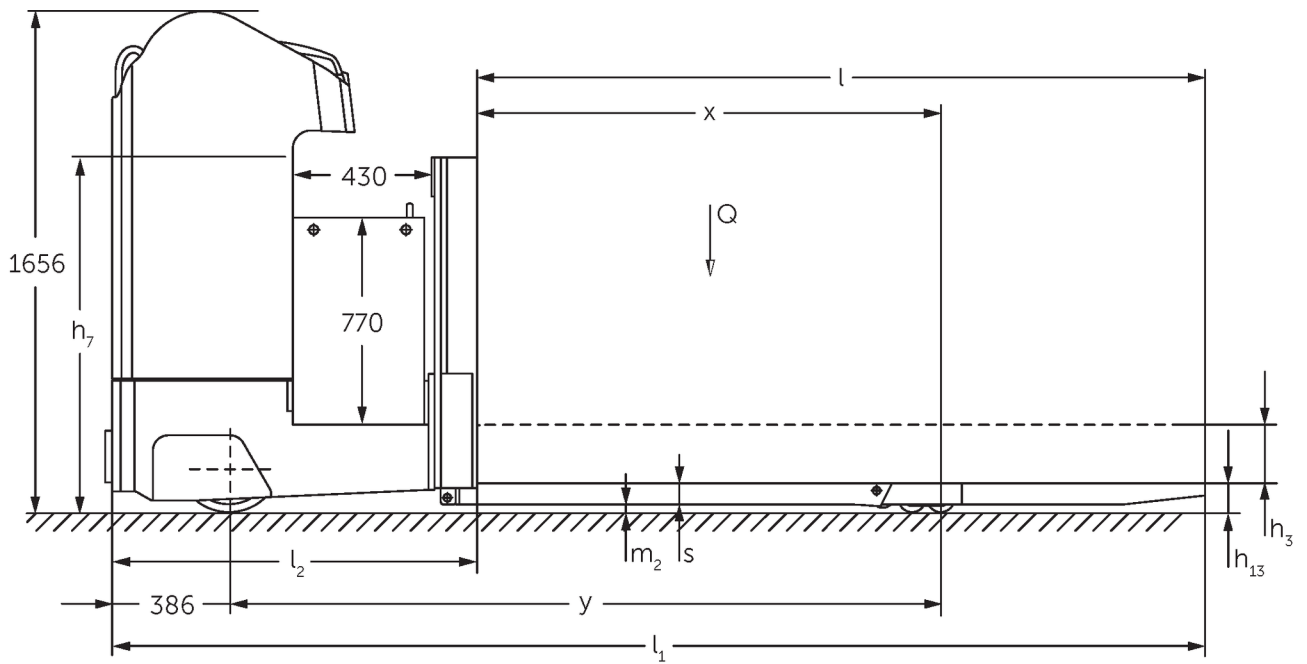

TZ ESE 430 022014

VDI table

Stand-on: 07/2022

Characteristic	1.1	Manufacturer (abbreviated description)		Jungheinrich	
	1.2	Manufacturer's type designation		ESE 430	
	1.3	Drive		Electric	
	1.4	Operation		Seat	
	1.5	Load capacity/load	Q	kg	3000
	1.6	Load centre distance	c	mm	1200
	1.8	Load distance, centre of drive axle to fork	x	mm	1480
	1.9	Wheelbase	y	mm	2211
	Weights	2.1.1	Service weight (incl. battery)		kg
2.2		Axle load laden front/rear		kg	2890 / 2980
2.3		Axle load unladen front/rear		kg	1916 / 559
Wheels/suspension system	3.1	Tyres			Vulkollan®
	3.2	Tyre size, front			Ø 343 x 114
	3.3	Tyre size, rear			Ø 90 x 92
	3.4	Additional wheels			Ø 285 x 100
	3.5	Wheels, number front/back (x=driven)			2 - 1x / 4
	3.6	Tread width, front	b ₁₀	mm	604
	3.7	Tread width, rear	b ₁₁	mm	380
Basic dimensions	4.4	Lift (h ₃)	h ₃	mm	115
	4.8	Seat height/stand height	h ₇	mm	1200
	4.15	Height, lowered	h ₁₃	mm	90
	4.19	Overall length	l ₁	mm	3625
	4.20	Length including fork shank	l ₂	mm	1225
	4.21.1	Overall width	b ₁	mm	1000
	4.22	Fork dimensions	s/e/l	mm	70 x 200 x 2400
	4.25	Width across forks	b ₅	mm	580
	4.32	Ground clearance centre of wheelbase	m ₂	mm	20
	4.34.2	Aisle width (pallet 800x1200 length)	A _{st}	mm	3953
	4.35	Turning radius	W _a	mm	2750
Performance data	5.1	Travel speed laden/unladen		km/h	13 / 14
	5.2	Lift speed laden/unladen		m/s	0.06 / 0.06
	5.3	Lowering speed laden/unladen		m/s	0.05 / 0.05
	5.7	Gradeability laden/unladen		%	6 / 15
	5.10	Service brake			electric
E-motor/Electronics	6.1	Drive motor, performance S2 60 min		kW	6.9
	6.2	Lift motor, performance with S3		kW	3
	6.3	Battery according to DIN 43531/35/36			A
	6.4	Battery voltage/nominal capacity		V / Ah	48 / 620
	6.5	Battery weight		kg	945
	6.6.1	Energy consumption according to EN cycle		kWh/h	0.56
	6.6.2	CO2 equivalent as per EN 16796		kg/h	0.3
Other	8.1	Type of drive control			Mosfet/AC

- This data sheet according to VDI guideline 2198 only states the technical values of the standard truck. Different tyres, other masts, additional equipment etc. may result in different values.

- VDI no. 1.8: lowered load section: + 89 mm
- VDI no. 1.9: lowered load section: + 89 mm
- VDI no. 4.34: ESE 420 / 430 diagonal as per VDI: + 128 mm. ESE 533 diagonal as per VDI: + 83 mm.
- VDI no. 4.35: lowered load section: + 89 mm

The German production facilities in
Norderstedt, Moosburg and Landsberg
are certified.

ISO 9001
ISO 14001

Jungheinrich fork lift trucks meet
European safety requirements.



 **JUNGHEINRICH**