

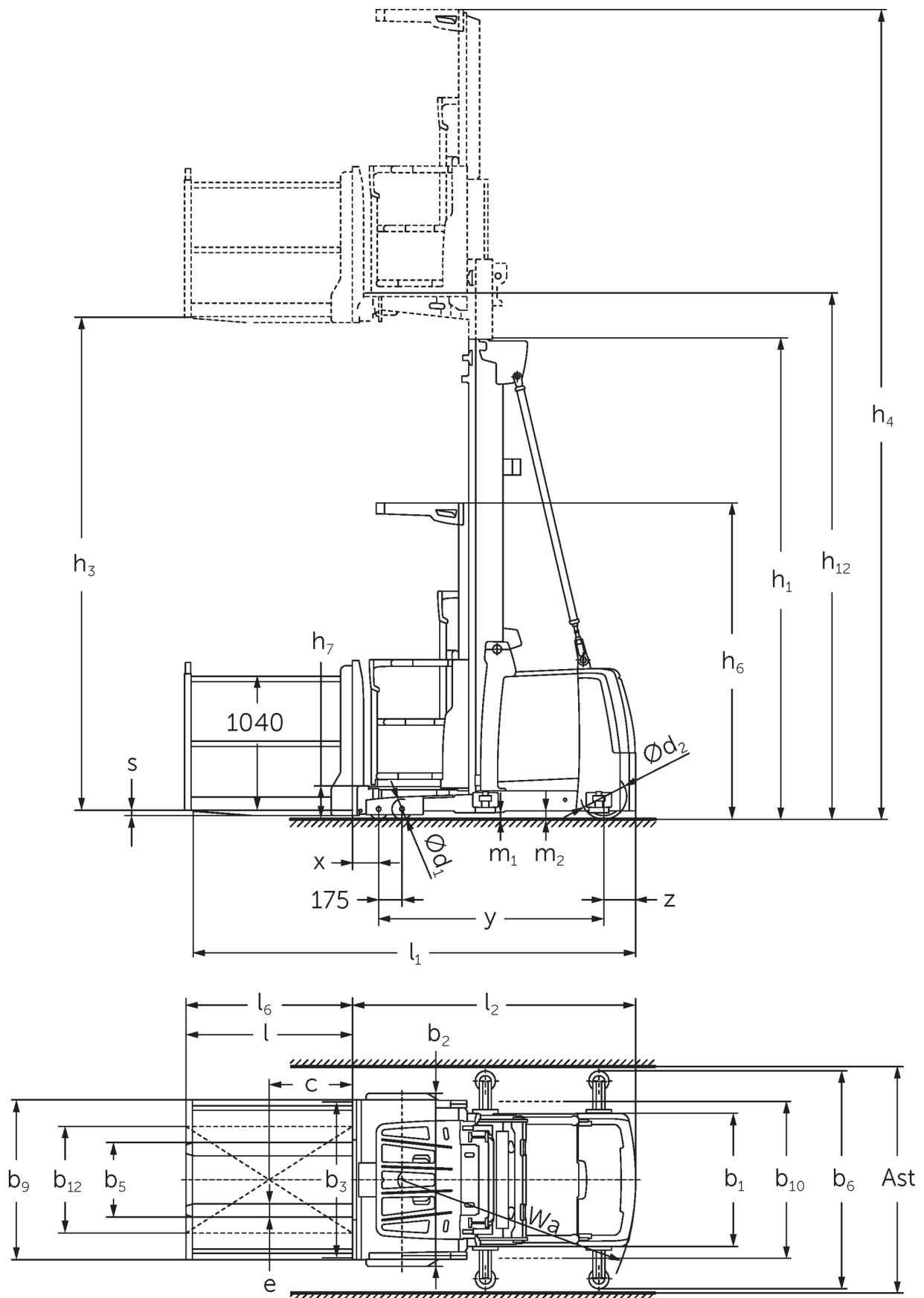

Medium/high level order picker **EKS 310 / 412**

Lift height: 7000-9000 mm / Load capacity: 1200 kg

EKS 310 / 412



EKS 310 / 412

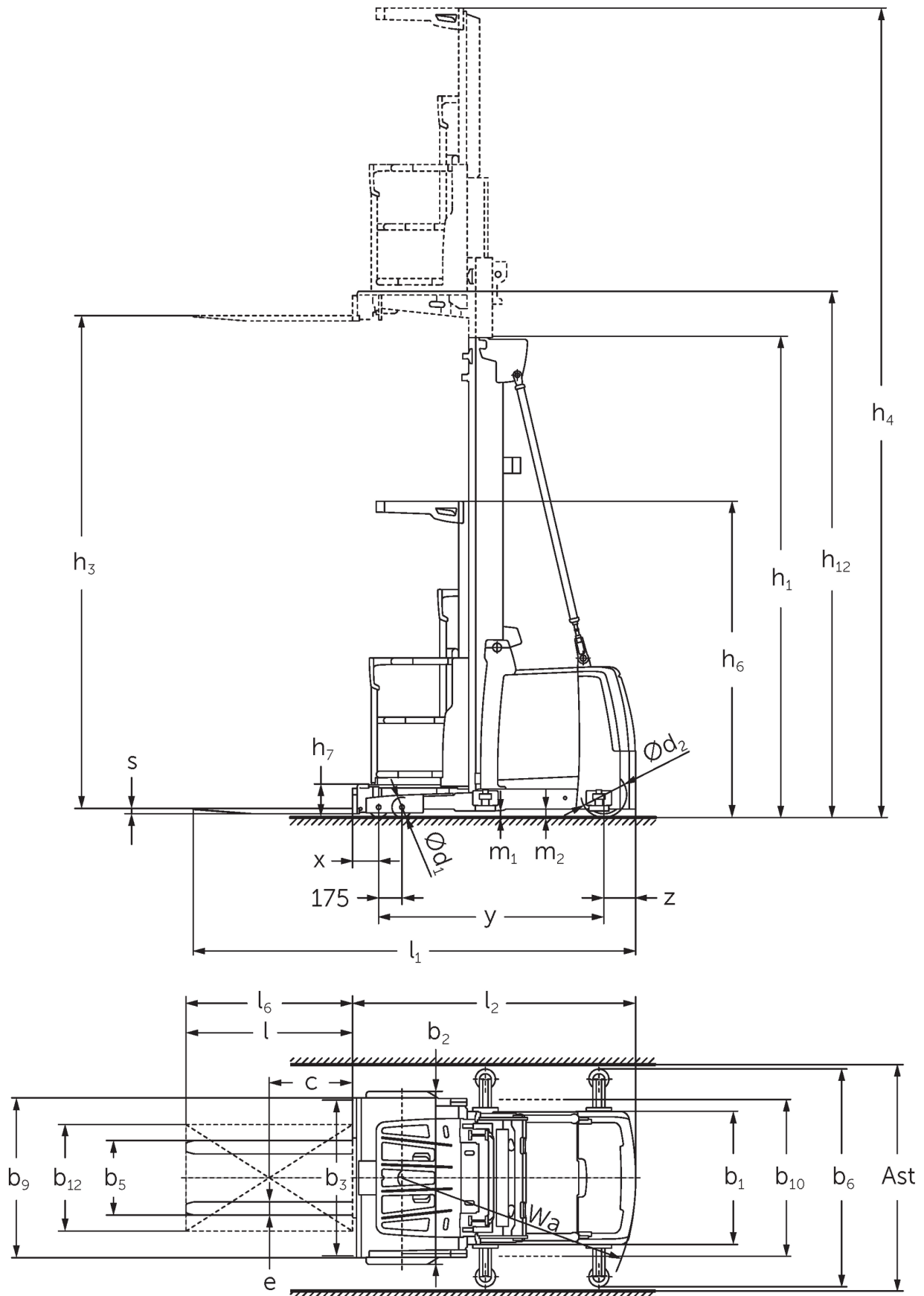

EKS 310 / 412



EKS 310 / 412

EKS 310 Z, EKS 310 L, EKS 310 O	Lift (h3)	Retracted mast height (h1)	Free lift (h2)	Extended mast height (h4)
Duplex mast ZT	2800 mm	2325 mm		5170 mm
	3500 mm	2550 mm		5870 mm
Triplex mast DT	4750 mm	2370 mm		7120 mm
Triplex mast DZ	4750 mm	2370 mm		7120 mm
EKS 310 Z, EKS 310 L, EKS 310 O, EKS 412 Z, EKS 412 L, EKS 412 O	Lift (h3)	Retracted mast height (h1)	Free lift (h2)	Extended mast height (h4)
Duplex mast ZT	4250 mm	2950 mm		6620 mm
	5000 mm	3330 mm		7370 mm
	5500 mm	3600 mm		7870 mm
	6000 mm	3850 mm		8370 mm
Triplex mast DT	5500 mm	2610 mm		7870 mm
	6000 mm	2780 mm		8370 mm
	6500 mm	2940 mm		8870 mm
	7000 mm	3110 mm		9370 mm
Triplex mast DZ	5500 mm	2610 mm	240 mm	7870 mm
	6000 mm	2780 mm	410 mm	8370 mm
	6500 mm	2940 mm	570 mm	8870 mm
	7000 mm	3110 mm	740 mm	9370 mm
EKS 412 Z, EKS 412 L, EKS 412 O	Lift (h3)	Retracted mast height (h1)	Free lift (h2)	Extended mast height (h4)
Duplex mast ZT	6500 mm	4125 mm		8870 mm
	7500 mm	4650 mm		9870 mm
	8500 mm	5150 mm		10870 mm
Triplex mast DT	7500 mm	3275 mm		9870 mm
	8000 mm	3440 mm		10370 mm
	8500 mm	3610 mm		10870 mm
	9000 mm	3810 mm		11370 mm
Triplex mast DZ	7500 mm	3275 mm	905 mm	9870 mm
	8000 mm	3440 mm	1070 mm	10370 mm
	8500 mm	3610 mm	1240 mm	10870 mm
	9000 mm	3810 mm	1440 mm	11370 mm

VDI table

Stand-on: 01/2024

Characteristic	1.1	Manufacturer (abbreviated description)		Jungheinrich					
	1.2	Manufacturer's type designation		EKS 3/4					
	1.3	Drive		Electric					
	1.4	Operation		Order pickers					
	1.5	Load capacity/load	Q kg	1000			1200		
	1.6	Load centre distance	c mm	400					
	1.8	Load distance, centre of drive axle to fork	x mm	155					
	1.9	Wheelbase	y mm	1520			1690		
	Weights	2.1.1	Service weight (incl. battery)	kg	2550		2500	3450	
2.2		Axle load laden front/rear	kg	2740 / 860	2770 / 830	2695 / 855	3425 / 1255	3455 / 1195	3380 / 1220
2.3		Axle load unladen front/rear	kg	1215 / 1335	1270 / 1330	1195 / 1355		1655 / 1795	1580 / 1820
Wheels/ suspension system	3.1	Tyres		Polyurethane (PU)					
	3.2	Tyre size, front		Ø 150 x 100					
	3.3	Tyre size, rear		Ø 250 x 80			Ø 343 x 114		
	3.5	Wheels, number front/back (x=driven)		4 / 1 x					
Basic dimensions	4.2	Retracted mast height (h1)	h1 mm	2950			3330		
	4.4	Lift (h3)	h3 mm	4250			5000		
	4.5	Extended mast height (h4)	h4 mm	6620			7370		
	4.7	Height of overhead guard (cab)	h6 mm	2370					
	4.8.1	Stand height	h7 mm	245					
	4.14	Stand height, elevated	h12 mm	4495			5245		
	4.15	Height, lowered	h13 mm	60					
	4.19	total length	l1 mm	3095	3140	3085	3285	3330	3275
	4.20	Length including fork shank	l2 mm	1895	1885		2085	2075	
	4.21.1	total width	b1 mm	900			1000		
	4.22	Fork dimensions	s/ e/l mm	40 x 100 x 1200	50 x 100 x 1250	50 x 100 x 1200	40 x 100 x 1200	50 x 100 x 1250	50 x 100 x 1200
	4.25	Width across forks	b5 mm	560					
	4.31	Ground clearance laden under mast	m1 mm	50					
4.35	Turning radius	Wa mm	1643			1845			
Performance data	5.1	Travel speed laden/unladen	km/h	10 / 10					
	5.2	Lift speed laden/unladen	m/s	0.25 / 0.3					
	5.3	Lowering speed laden/unladen	m/s	0.3 / 0.25					
	5.10	Service brake		regenerative					
	5.11	Parking brake		Electric sprung-loaded					
E-motor/ Electronics	6.1	Drive motor, performance S2 60 min	kW	3			6		
	6.2	Lift motor, performance with S3	kW	8					
	6.3	Battery according to DIN 43531/35/36		6 PzS 930			8 PzS 1240		
	6.4	Battery voltage/nominal capacity	V / Ah	24 / 930			24 / 1240		
	6.5	Battery weight	kg	700			910		
Other	8.1	Type of drive control		AC drive control system					
	10.5	Steering version		electric					
	10.7	Sound level as per EN12053, operator's ear	dB (A)	60			65		

- This data sheet according to VDI guideline 2198 only states the technical values of the standard truck. Different tyres, other masts, additional equipment etc. may result in different values.

The German production facilities in
Norderstedt, Moosburg and Landsberg
are certified as well as our Genuine Parts
Center in Kaltenkirchen. ISO 9001
ISO 14001

Jungheinrich fork lift trucks meet
European safety requirements. 

**JUNGHEINRICH**