



Electric high level combination order picker / tri-lateral stacker

EKX 410-516

Lift height: 3000-18000 mm / Load capacity: 1000-1600 kg

EKX 410-516

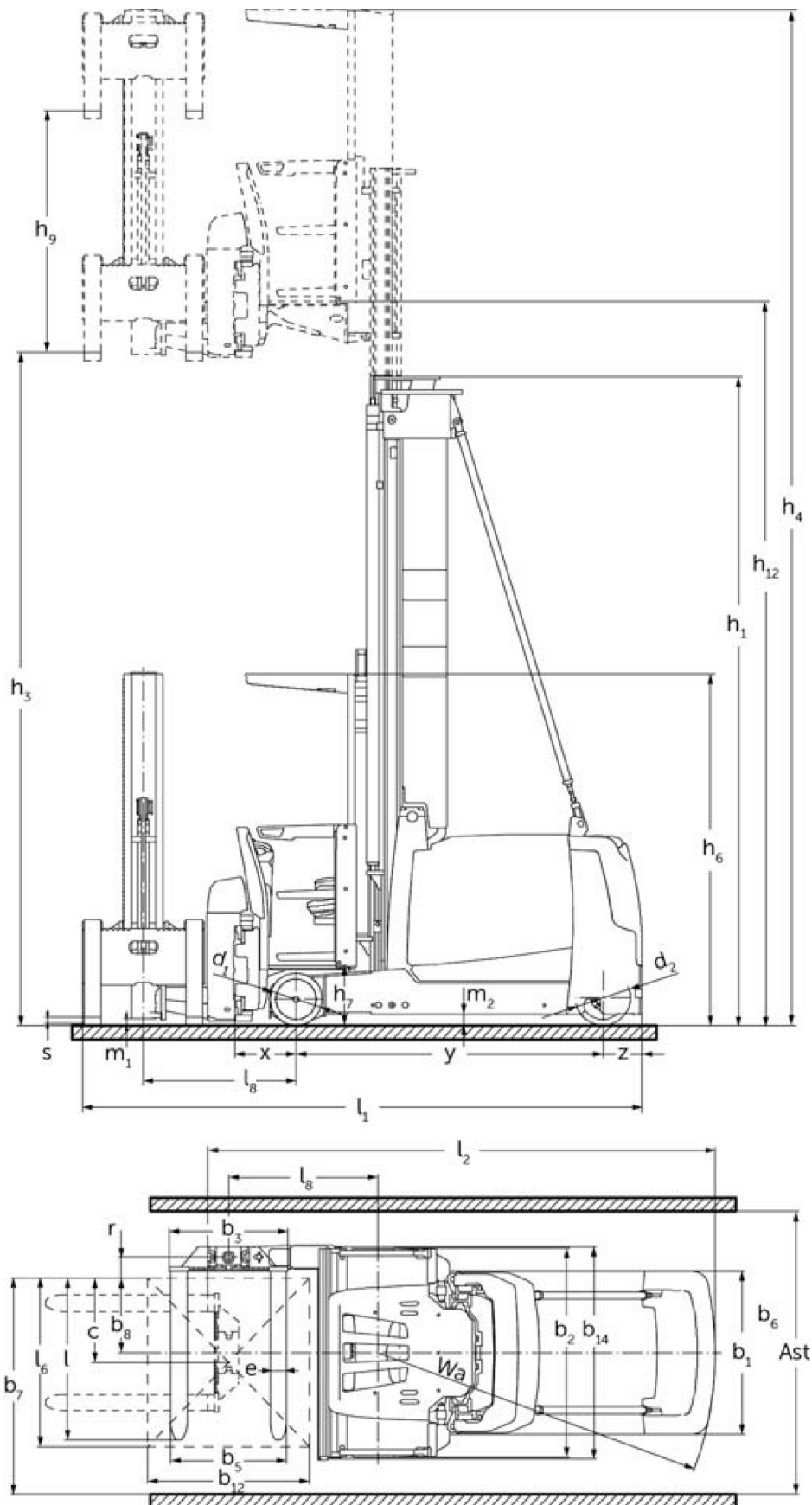

EKX 410-516

EKX 410, EKX 412	Lift (h3)	Retracted mast height (h1)	Free lift (h2)	Extended mast height (h4)
Duplex mast ZT	3000 mm	2600 mm		5550 mm
	3500 mm	2850 mm		6050 mm
	4000 mm	3100 mm		6550 mm
	4500 mm	3350 mm		7050 mm
	5000 mm	3600 mm		7550 mm
	5500 mm	3850 mm		8050 mm
	6000 mm	4100 mm		8550 mm
	6500 mm	4375 mm		9050 mm
	7000 mm	4650 mm		9550 mm
	7500 mm	4925 mm		10050 mm
Triplex mast DZ	4500 mm	2625 mm	75 mm	7050 mm
	5000 mm	2800 mm	250 mm	7550 mm
	5500 mm	2975 mm	425 mm	8050 mm
	6000 mm	3150 mm	600 mm	8550 mm
	6500 mm	3325 mm	775 mm	9050 mm
	7000 mm	3500 mm	950 mm	9550 mm
	7500 mm	3675 mm	1125 mm	10050 mm
EKX 412	Lift (h3)	Retracted mast height (h1)	Free lift (h2)	Extended mast height (h4)
Duplex mast ZT	8000 mm	5200 mm		10550 mm
	8500 mm	5475 mm		11050 mm
Triplex mast DZ	8000 mm	3850 mm	1300 mm	10550 mm
	8500 mm	4025 mm	1475 mm	11050 mm
EKX 514, EKX 516k, EKX 516	Lift (h3)	Retracted mast height (h1)	Free lift (h2)	Extended mast height (h4)
Duplex mast ZT	3000 mm	2705 mm		5550 mm
	3500 mm	2955 mm		6050 mm
	4000 mm	3205 mm		6550 mm
	4500 mm	3455 mm		7050 mm
	5000 mm	3705 mm		7550 mm
	5500 mm	3955 mm		8050 mm
	6000 mm	4205 mm		8550 mm
	6500 mm	4555 mm		9050 mm
	7000 mm	4805 mm		9550 mm
	7500 mm	5055 mm		10050 mm
	8000 mm	5305 mm		10550 mm
	8500 mm	5655 mm		11050 mm
	9000 mm	5905 mm		11550 mm
	9500 mm	6155 mm		12050 mm
	Triplex mast DZ	4000 mm	2550 mm	
4500 mm		2710 mm	160 mm	7050 mm
5000 mm		2895 mm	345 mm	7550 mm
5500 mm		3095 mm	545 mm	8050 mm
6000 mm		3295 mm	745 mm	8550 mm
6500 mm		3495 mm	945 mm	9050 mm
7000 mm		3695 mm	1145 mm	9550 mm
7500 mm		3895 mm	1345 mm	10050 mm
8000 mm		4095 mm	1545 mm	10550 mm

	8500 mm	4295 mm	1745 mm	11050 mm
	9000 mm	4495 mm	1945 mm	11550 mm
	9250 mm	4595 mm	2045 mm	11800 mm
	9500 mm	4695 mm	2145 mm	12050 mm
EKX 516	Lift (h3)	Retracted mast height (h1)	Free lift (h2)	Extended mast height (h4)
Triplex mast DZ	11000 mm	5215 mm	2665 mm	13550 mm
	11500 mm	5395 mm	2845 mm	14050 mm
	12000 mm	5565 mm	3015 mm	14550 mm
	12500 mm	5750 mm	3200 mm	15050 mm
	13000 mm	5950 mm	3400 mm	15550 mm
	13500 mm	6250 mm	3700 mm	16050 mm
	14000 mm	6550 mm	4000 mm	16550 mm
	14500 mm	6850 mm	4300 mm	17050 mm
EKX 516k, EKX 516	Lift (h3)	Retracted mast height (h1)	Free lift (h2)	Extended mast height (h4)
Duplex mast ZT	10000 mm	6405 mm		12550 mm
	10500 mm	6655 mm		13050 mm
Triplex mast DZ	10000 mm	4875 mm	2325 mm	12550 mm
	10500 mm	5045 mm	2495 mm	13050 mm

VDI table

Stand-on: 04/2024

Characteristic	1.1	Manufacturer (abbreviated description)	Jungheinrich				
	1.2	Manufacturer's type designation	EKX 410	EKX 412	EKX 514	EKX 516k	EKX 516
	1.3	Drive	Electric				
	1.4	Operation	Order picker / tri-lateral stacker				
	1.5	Load capacity/load	Q kg	1000	1200	1400	1600
	1.6	Load centre distance	c mm	600			
	1.8	Load distance, centre of drive axle to fork	x mm	450		445	
	1.9	Wheelbase	y mm	1807		1840	1950 2220
	1.10	Mitte Antriebsrad/Gegengewicht	z mm	320		282	
Weights	2.1.1	Service weight (incl. battery)	kg	5515	5895	6350	6750 7900
	2.2	Axle load laden front/rear	kg	4895 / 1630	5400 / 1705	5720 / 1880	6190 / 2060 6590 / 2810
	2.3	Axle load unladen front/rear	kg	3270 / 2245	3450 / 2445	3850 / 2500	3980 / 2770 4480 / 3420
Wheels/suspension system	3.1	Tyres	Bestthane				
	3.2	Tyre size, front	Ø 295 x 144			Ø 380 x 192	
	3.3	Tyre size, rear	Ø 343 x 110			Ø 400 x 160	
	3.5	Wheels, number front/back (x=driven)	2 / 1 x			2 / 1x	
	3.6	Tread width, front	b10 mm	1306		1258	
	Basic dimensions	4.2	Retracted mast height (h1)	h1 mm	2850		2955
4.3		Free lift (h2)	h2 mm	0			
4.4		Lift (h3)	h3 mm	3500			
4.5		Extended mast height (h4)	h4 mm	6050			
4.7		Height of overhead guard (cab)	h6 mm	2550			
4.8		Seat height/stand height	h7 mm	430			
4.11		Additional lift	h9 mm	1780			
4.14		Stand height, elevated	h12 mm	3930			
4.19		total length	l1 mm	3665		3775	4045
4.20		Length including fork shank	l2 mm	3379		3489	3759
4.21.1		total width	b1 mm	1210			
4.21.2		total width	b2 mm	1450			
4.22		Fork dimensions	s/ e/l mm	40 x 120 x 1200		50 x 120 x 1200	
4.23		Fork carriage connection class		2B			
4.24		Fork carriage width	b3 mm	880			
4.25		Width across forks	b5 mm	856			
4.29		Reach, lateral	mm	1300			
4.30		Reach, lateral from centre of truck	mm	480			
4.31		Ground clearance laden under mast	m1 mm	80			
4.32		Ground clearance centre of wheelbase	m2 mm	80			
4.35		Turning radius	Wa mm	2122		2232	2502
4.38		Distance swivelling fork pivot point	mm	1103			
4.38.4		Pallet width	mm	1200			
4.38.5	Pallet length	mm	1200				
Performance data	5.1	Travel speed laden/unladen	km/h	10.5 / 10.5		12 / 12	
	5.2	Lift speed laden/unladen	m/s	0.4 / 0.4		0.45 / 0.45	0.6 / 0.6
	5.3	Lowering speed laden/unladen	m/s	0.4 / 0.4		0.5 / 0.5	
	5.4	Reach speed laden/unladen	m/s	0.4 / 0.4		0.4 / 0.5	
	5.10	Service brake		regenerative			
	5.11	Parking brake		Electric sprung-loaded			

E-motor/ Electronics	6.1	Drive motor, performance S2 60 min	kW	6.9		9		
	6.2	Lift motor, performance with S3	kW	10		25		
	6.3	Battery according to DIN 43531/35/36		6 PzS 750	6 PzS 930	3 PzS 465	4 PzS 620	6 PzS 930
	6.4	Battery voltage/nominal capacity	V / Ah	48 / 750	48 / 930	80 / 465	80 / 620	80 / 930
	6.5	Battery weight	kg	1011	1388	1238	1558	2178
Other	8.1	Type of drive control		AC synchronous reluctance				
	10.5	Steering version		electric				
	10.7	Sound level as per EN12053, operator's ear	dB (A)	64				

- This data sheet according to VDI guideline 2198 only states the technical values of the standard truck. Different tyres, other masts, additional equipment etc. may result in different values.

The German production facilities in
Norderstedt, Moosburg and Landsberg
are certified as well as our Genuine Parts
Center in Kaltenkirchen. ISO 9001
ISO 14001

Jungheinrich fork lift trucks meet
European safety requirements. 

**JUNGHEINRICH**