



Electric hand stacker

HC 110

Lift height: 1600-3000 mm / Load capacity: 1000 kg

JUNGHEINRICH

HC 110

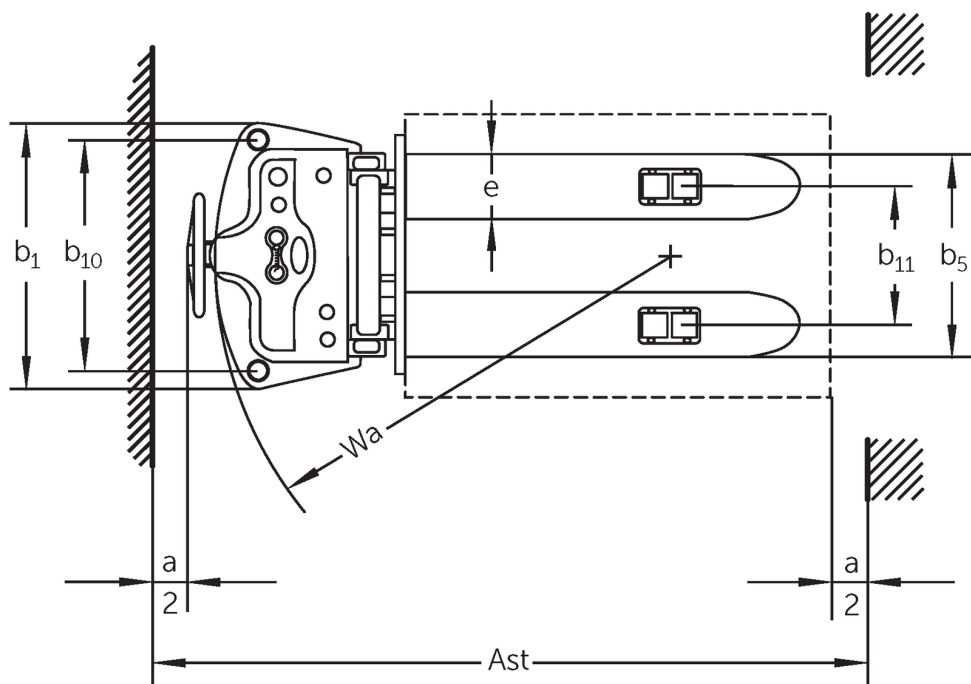
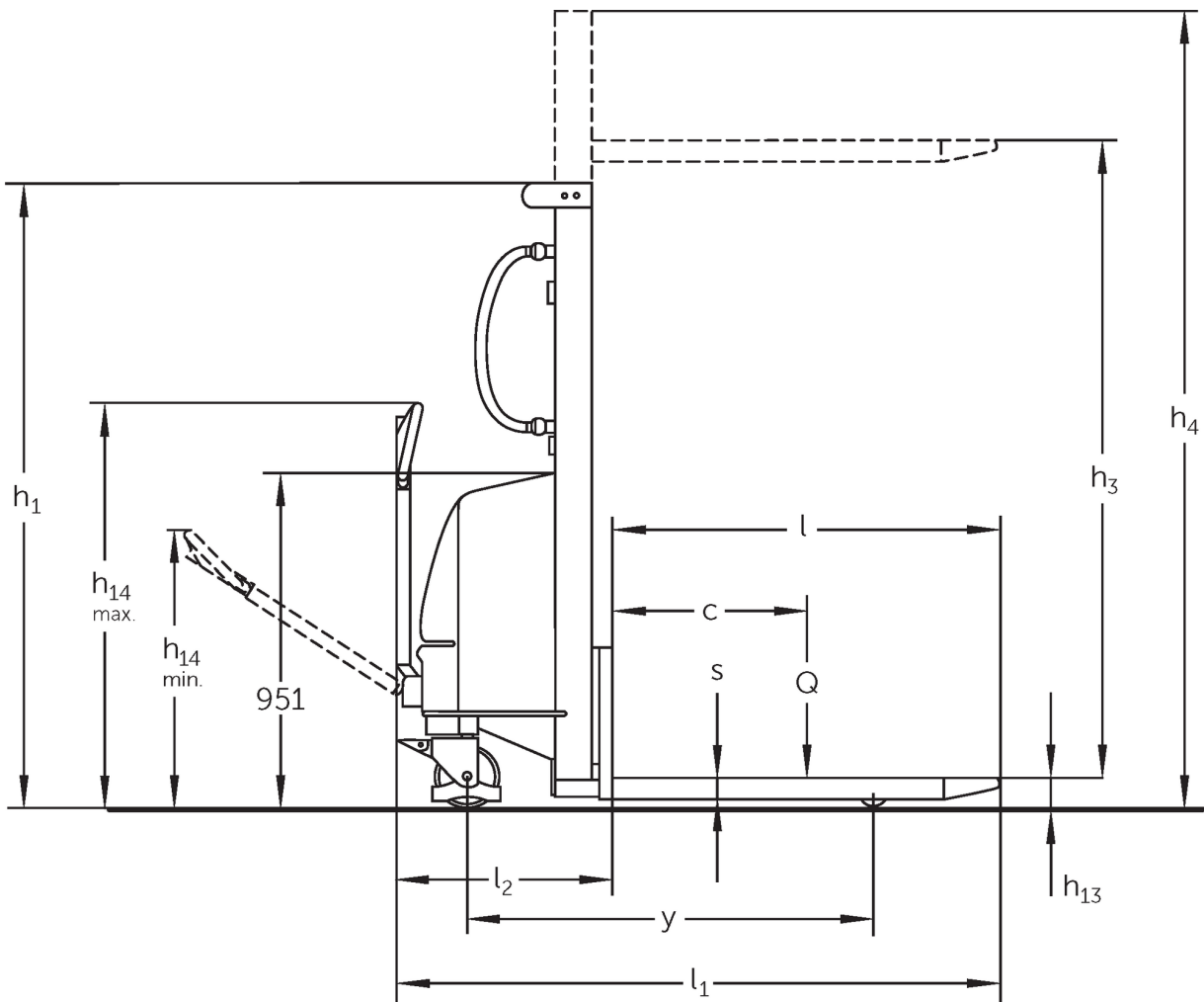

VDI table

Stand-on: 04/2024

Characteristic	1.1	Manufacturer (abbreviated description)		Jungheinrich		
	1.2	Manufacturer's type designation		HC 110		
	1.3	Drive		Manual		
	1.4	Operation		Pedestrian		
	1.5	Load capacity/load	Q kg	1000		
	1.6	Load centre distance	c mm	600		
	1.9	Wheelbase	y mm	1210		
Weights	2.1.1	Service weight (incl. battery)	kg	348	435	450
	2.2	Axle load laden front/rear	kg	400 / 948	443 / 992	454 / 996
	2.3	Axle load unladen front/rear	kg	242 / 106	306 / 129	323 / 127
Wheels/suspension system	3.1	Tyres		Rubber / nylon		
	3.2	Tyre size, front		Ø 180 x 50		
	3.3	Tyre size, rear		Ø 74 x 93		
	3.5	Wheels, number front/back (x=driven)		2/2		
	3.6	Tread width, front	b10 mm	680		
	3.7	Tread width, rear	b11 mm	400		
	Basic dimensions	4.2	Retracted mast height (h1)	h1 mm	1980	1830
4.4		Lift (h3)	h3 mm	1600	2500	3000
4.5		Extended mast height (h4)	h4 mm	1980	3070	3570
4.9		Height of tiller handle in drive position min./max.	h14 mm	790 / 1156		
4.15		Height, lowered	h13 mm	85		
4.19		total length	l1 mm	1720		
4.20		Length including fork shank	l2 mm	620		
4.21.1		total width	b1 mm	777		
4.22		Fork dimensions	s/e/ l mm	60 x 180 x 1100		
4.25		Width across forks	b5 mm	570		
4.34.1		Aisle width (pallet 1000x1200 sideways)	Ast mm	2145		
4.34.2		Aisle width (pallet 800x1200 length)	Ast mm	2175		
4.35		Turning radius	Wa mm	1335		
Performance data	5.2	Lift speed laden/unladen	m/s	0.08 / 0.11		
	5.3	Lowering speed laden/unladen	m/s	0.19 / 0.13		
E-motor/ Electronics	6.2	Lift motor, performance with S3	kW	1.5		
	6.4	Battery voltage/nominal capacity	V / Ah	12 / 150		
	6.5	Battery weight	kg	45		
	6.6	Energy consumption according to VDI cycle	kWh/h	0		

- This data sheet according to VDI guideline 2198 only states the technical values of the standard truck. Different tyres, other masts, additional equipment etc. may result in different values.

The German production facilities in
Norderstedt, Moosburg and Landsberg
are certified as well as our Genuine Parts
Center in Kaltenkirchen. ISO 9001
ISO 14001

Jungheinrich fork lift trucks meet
European safety requirements. 

 **JUNGHEINRICH**