

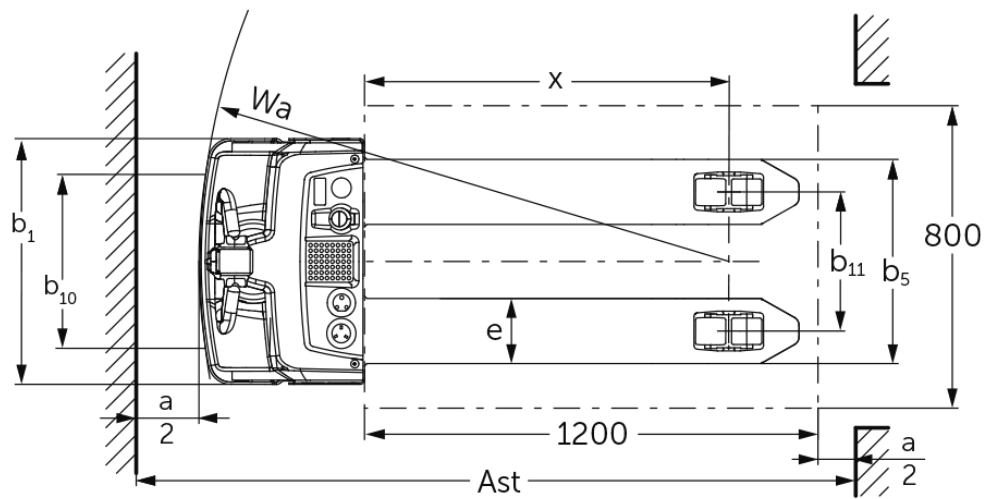

Electric pedestrian pallet truck **EJE M13 / M15**

Lift height: 120 mm / Load capacity: 1300-1500 kg

EJE M13 / M15

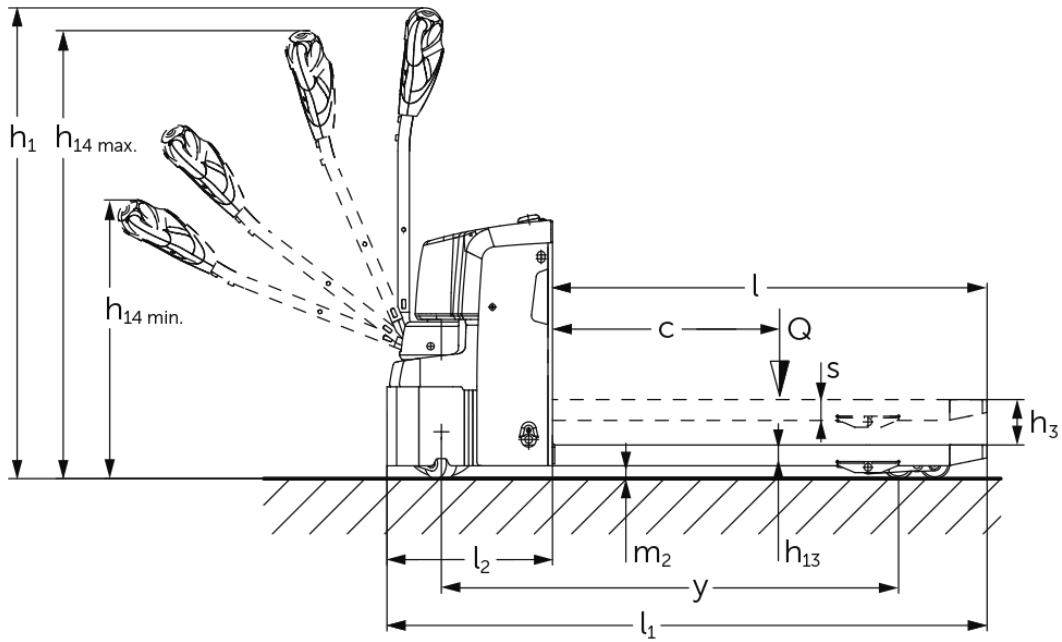

VDI table

Stand-on: 04/2024

Characteristic	1.1	Manufacturer (abbreviated description)	Jungheinrich							
	1.2	Manufacturer's type designation	EJE M13 (540x1,150)	EJE M13 (550x1,150) with weighing function	EJE M15 (670x1,000)	EJE M15 (540x1,150)	EJE M15 (550x1,150) with weighing function	EJE M15 (670 x 1,000)		
	1.3	Drive	Electric							
	1.4	Operation	Pedestrian							
	1.5	Load capacity/load	Q	kg	1300		1500			
	1.6	Load centre distance	c	mm	600					
	1.8	Load distance, centre of drive axle to fork	x	mm	914	894	764	914	894	764
	1.9	Wheelbase	y	mm	1212		1062	1212		1062
Weights	2.1.1	Service weight (incl. battery)		kg	219	224	219		224	219
	2.2	Axle load laden front/rear		kg	703 / 816	735 / 809	700 / 1019		730 / 1014	700 / 1019
	2.3	Axle load unladen front/rear		kg	166 / 53	176 / 68	166 / 53		176 / 68	166 / 53
Wheels/suspension system	3.1	Tyres	TPU/PU							
	3.2	Tyre size, front	Ø210x70							
	3.3	Tyre size, rear	Ø80x70							
	3.4	Additional wheels	2 x Ø80x40							
	3.5	Wheels, number front/back (x=driven)	1x+2/4							
	3.6	Tread width, front	b10	mm	460					
	3.7	Tread width, rear	b11	mm	368					
Basic dimensions	4.4	Lift (h3)	h3	mm	120					
	4.9	Height of tiller handle in drive position min./max.	h14	mm	740 / 1190					
	4.15	Height, lowered	h13	mm	85	90	85		90	85
	4.19	total length	l1	mm	1585	1605	1435	1585	1605	1435
	4.20	Length including fork shank	l2	mm	435	455	435		455	435
	4.21.1	total width	b1	mm	650					670
	4.22	Fork dimensions	s/ e/l	mm	55 x 172 x 1150	60 x 182 x 1150	55 x 172 x 1000	55 x 172 x 1150	60 x 182 x 1150	55 x 172 x 1000
	4.25	Width across forks	b5	mm	540	550	540		550	670
	4.32	Ground clearance centre of wheelbase	m2	mm	35					
	4.34.1	Aisle width (pallet 1000x1200 sideways)	Ast	mm	1643	1663	1493	1643	1663	1493
	4.34.2	Aisle width (pallet 800x1200 length)	Ast	mm	1843	1863	1693	1843	1863	1693
4.35	Turning radius	Wa	mm	1357		1207	1357		1207	
Performance data	5.1	Travel speed laden/unladen		km/h	5 / 5					
	5.2	Lift speed laden/unladen		m/s	0.05 / 0.06					
	5.3	Lowering speed laden/unladen		m/s	0.04 / 0.02					

	5.8	Max. gradeability laden/unladen	%	6 / 16
	5.10	Service brake		electric
E-motor/Electronics	6.1	Drive motor, performance S2 60 min	kW	1
	6.2	Lift motor, performance with S3	kW	1.2
	6.3	Battery according to DIN 43531/35/36		no
	6.4	Battery voltage/nominal capacity	V / Ah	24 / 50
	6.5	Battery weight	kg	15
	6.6	Energy consumption according to VDI cycle	kWh/h	0.32
	6.6.1	Energy consumption according to EN cycle	kWh/h	0.16
	6.6.2	CO2 equivalent as per EN 16796	kg/h	0.1
Other	8.1	Type of drive control		BLDC brushless direct current
	10.7	Sound level as per EN12053, operator's ear	dB (A)	64

- This data sheet according to VDI guideline 2198 only states the technical values of the standard truck. Different tyres, other masts, additional equipment etc. may result in different values.

Characteristic	1.1	Manufacturer (abbreviated description)		Jungheinrich
	1.2	Manufacturer's type designation		EJE M15 (670 x 1,150)
	1.3	Drive		Electric
	1.4	Operation		Pedestrian
	1.5	Load capacity/load	Q kg	1500
	1.6	Load centre distance	c mm	600
	1.8	Load distance, centre of drive axle to fork	x mm	914
	1.9	Wheelbase	y mm	1212
	Weights	2.1.1	Service weight (incl. battery)	kg
2.2		Axle load laden front/rear	kg	700 / 1019
2.3		Axle load unladen front/rear	kg	166 / 53
Wheels/suspension system	3.1	Tyres		TPU/PU
	3.2	Tyre size, front		Ø210x70
	3.3	Tyre size, rear		Ø80x70
	3.4	Additional wheels		2 x Ø80x40
	3.5	Wheels, number front/back (x=driven)		1x+2/4
	3.6	Tread width, front	b10 mm	460
	3.7	Tread width, rear	b11 mm	368
Basic dimensions	4.4	Lift (h3)	h3 mm	120

	4.9	Height of tiller handle in drive position min./max.	h14 mm	740 / 1190
	4.15	Height, lowered	h13 mm	85
	4.19	total length	l1 mm	1585
	4.20	Length including fork shank	l2 mm	435
	4.21.1	total width	b1 mm	670
	4.22	Fork dimensions	s/e/l mm	55 x 172 x 1150
	4.25	Width across forks	b5 mm	670
	4.32	Ground clearance centre of wheelbase	m2 mm	35
	4.34.1	Aisle width (pallet 1000x1200 sideways)	Ast mm	1643
	4.34.2	Aisle width (pallet 800x1200 length)	Ast mm	1843
	4.35	Turning radius	Wa mm	1357
Performance data	5.1	Travel speed laden/unladen	km/h	5 / 5
	5.2	Lift speed laden/unladen	m/s	0.05 / 0.06
	5.3	Lowering speed laden/unladen	m/s	0.04 / 0.02
	5.8	Max. gradeability laden/unladen	%	6 / 16
	5.10	Service brake		electric
E-motor/Electronics	6.1	Drive motor, performance S2 60 min	kW	1
	6.2	Lift motor, performance with S3	kW	1.2
	6.3	Battery according to DIN 43531/35/36		no
	6.4	Battery voltage/nominal capacity	V / Ah	24 / 50
	6.5	Battery weight	kg	15
	6.6	Energy consumption according to VDI cycle	kWh/h	0.32
	6.6.1	Energy consumption according to EN cycle	kWh/h	0.16
	6.6.2	CO2 equivalent as per EN 16796	kg/h	0.1
Other	8.1	Type of drive control		BLDC brushless direct current
	10.7	Sound level as per EN12053, operator's ear	dB (A)	64

- This data sheet according to VDI guideline 2198 only states the technical values of the standard truck. Different tyres, other masts, additional equipment etc. may result in different values.

With silentDRIVE option (not possible with weighing function):

- VDI no. 3.3: load wheel: \varnothing 85 x 32 mm.
- VDI no. 4.22: fork dimensions: e = 150 mm.
- VDI no. 4.25: width across forks: b5 = 520 mm
- VDI no. 5.2: lift speed laden / unladen: 0.034 / 0.04 m/s.
- VDI no. 5.3: lowering speed laden / unladen: 0.04 / 0.02 m/s.
- VDI no. 6.2: lift motor, performance with S3: 0.8 kW.
- VDI no. 10.7: sound pressure level as per EN12053, operator's ear: 60 dB(A).

The German production facilities in
Norderstedt, Moosburg and Landsberg
are certified as well as our Genuine Parts
Center in Kaltenkirchen. ISO 9001
ISO 14001

Jungheinrich fork lift trucks meet
European safety requirements. 

 **JUNGHEINRICH**