



## **Low level order pickers with ergonomic lift**

### **ECD 320**

Lift height: 700-1500 mm / Load capacity: 2000 kg

# ECD 320

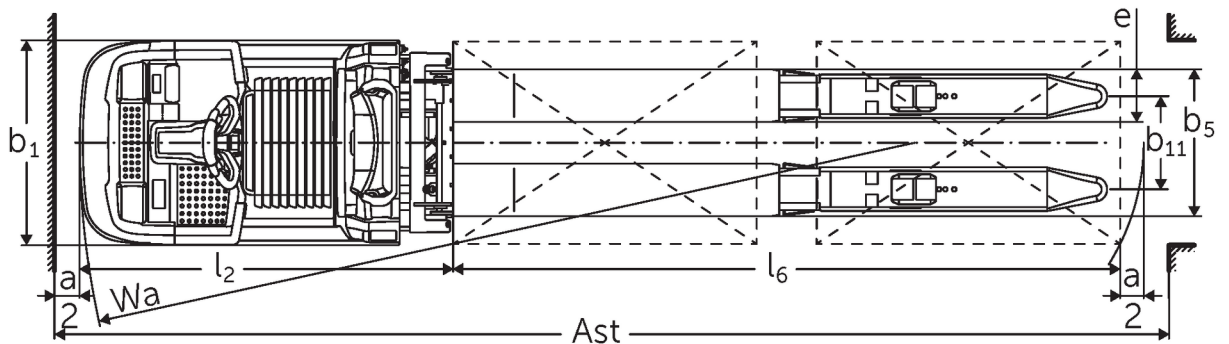
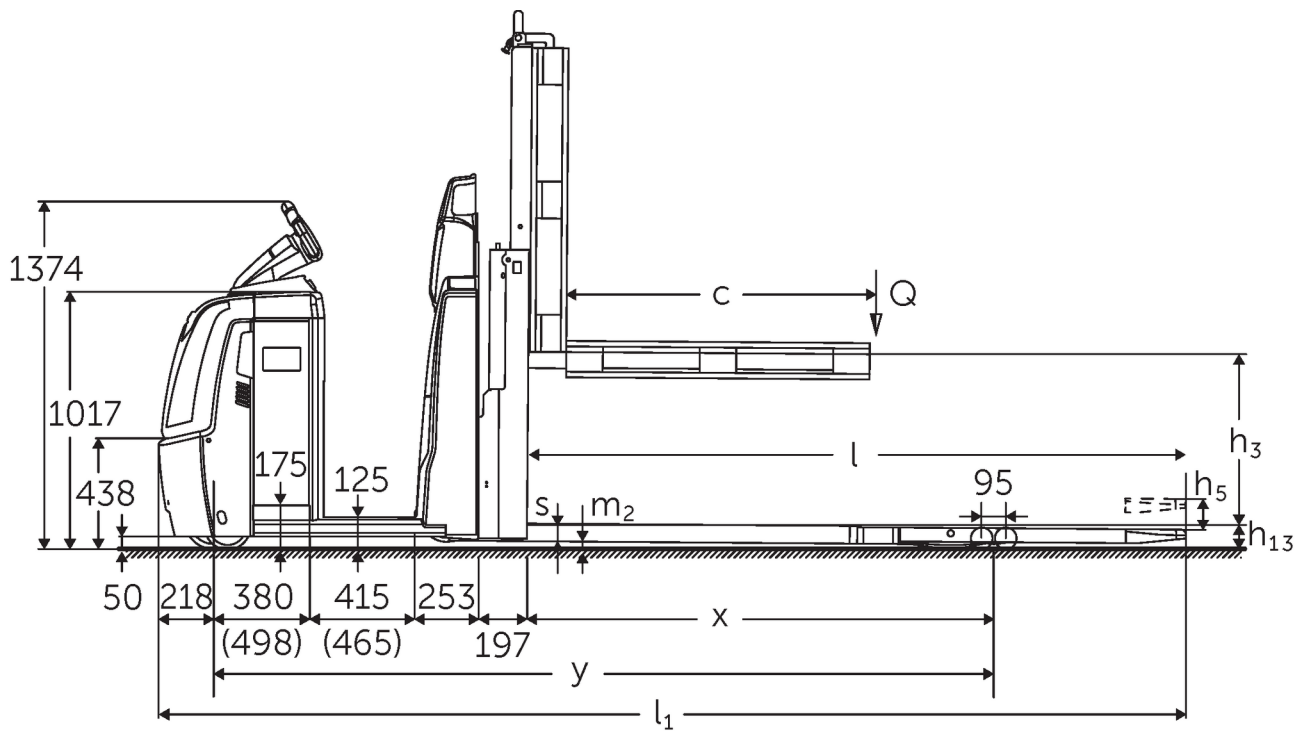

ECD 320 NOC 2016 Techn

# VDI table

Stand-on: 05/2024

Characteristic	1.1	Manufacturer (abbreviated description)		Jungheinrich
	1.2	Manufacturer's type designation		<b>ECD 320</b>
	1.3	Drive		Electric
	1.4	Operation		Order pickers
	1.5	Load capacity/load	Q kg	2000
	1.6	Load centre distance	c mm	1300
	1.8	Load distance, centre of drive axle to fork	x mm	1718
	1.9	Wheelbase	y mm	2981
	Weights	2.1.1	Service weight (incl. battery)	kg
2.2		Axle load laden front/rear	kg	1155 / 2080
2.3		Axle load unladen front/rear	kg	920 / 315
Wheels/suspension system	3.1	Tyres		Polyurethane (PU)
	3.2	Tyre size, front		Ø 230 x 78
	3.3	Tyre size, rear		Ø 85 x 85
	3.4	Additional wheels		Ø 180 x 65
	3.5	Wheels, number front/back (x=driven)		1+1x/4
	3.6	Tread width, front	b10 mm	481
	3.7	Tread width, rear	b11 mm	368
Basic dimensions	4.4	Lift (h3)	h3 mm	700
	4.9	Height of tiller handle in drive position min./max.	h14 mm	1374 / 1418
	4.15	Height, lowered	h13 mm	90
	4.19	total length	l1 mm	4081
	4.20	Length including fork shank	l2 mm	1480
	4.21.1	total width	b1 mm	810
	4.22	Fork dimensions	s/e/l mm	65 x 172 x 2600
	4.25	Width across forks	b5 mm	540
	4.32	Ground clearance centre of wheelbase	m2 mm	25
	4.34.2	Aisle width (pallet 800x1200 length)	Ast mm	4281
	4.35	Turning radius	Wa mm	3199
Performance data	5.1	Travel speed laden/unladen (Efficiency   drivePLUS)	km/h	9.2 / 12.5   9.2 / 14
	5.2	Lift speed laden/unladen	m/s	0.07 / 0.11
	5.3	Lowering speed laden/unladen	m/s	0.07 / 0.06
	5.8	Max. gradeability laden/unladen (Efficiency   drivePLUS)	%	6 / 15   6 / 15
	5.10	Service brake		generative
E-motor/Electronics	6.1	Drive motor, performance S2 60 min (Efficiency   drivePLUS)	kW	2.8   3.2
	6.2	Lift motor, performance with S3	kW	1.5
	6.4	Battery voltage/nominal capacity	V / Ah	24 / 465
	6.5	Battery weight	kg	370
	6.6.1	Energy consumption according to EN cycle	kWh/h	0.53
	6.6.2	CO2 equivalent as per EN 16796	kg/h	0.3
	6.7	Throughput	t/h	136
	6.8.1	Energy consumption with max. throughput	kWh/h	1.36
Other	8.1	Type of drive control		AC
	10.5	Steering version		electric
	10.7	Sound level as per EN12053, operator's ear	dB (A)	62

- This data sheet according to VDI guideline 2198 only states the technical values of the standard truck. Different tyres, other masts, additional equipment etc. may result in different values.

Efficiency: Values of standard package | PLUS: Values of performance package

Values for L battery compartment; fork length 2,450 mm; lift 700 mm; raised load section.

- VDI no. 1.8: with lowered load section:  $x + 82$  mm.

- VDI no. 1.9: with XL or XL (ERE) battery compartment:  $y + 118$  mm; with extended stand-on platform:  $y + 50$  mm; with lowered load section:  $y + 82$  mm.

- VDI no. 4.19: with XL or XL (ERE) battery compartment:  $l1 + 118$  mm; with extended stand-on platform:  $l1 + 50$  mm.

- VDI no. 4.20: with XL or XL (ERE) battery compartment:  $l2 + 118$  mm; with extended stand-on platform:  $l2 + 50$  mm.

- VDI no. 4.34.2: with XL or XL (ERE) battery compartment: aisle width + 118 mm; with extended stand-on platform: aisle width + 50 mm; diagonal as per VDI: aisle width + 94 mm.

- VDI no. 4.35: with XL or XL (ERE) battery compartment:  $Wa + 118$  mm; with extended stand-on platform:  $Wa + 50$  mm; with lowered load section:  $Wa + 82$  mm.

- VDI no. 6.2: with S3 10%.

- VDI no. 6.4: with XL battery compartment: 24 V / 620 Ah.

- VDI no. 6.5: with XL battery compartment: 460 kg.

The German production facilities in  
Norderstedt, Moosburg and Landsberg  
are certified as well as our Genuine Parts  
Center in Kaltenkirchen. ISO 9001  
ISO 14001

Jungheinrich fork lift trucks meet  
European safety requirements. 

**JUNGHEINRICH**