



Hand pallet truck **AM V05**

Lift height: 390 mm / Load capacity: 500 kg

JUNGHEINRICH

AM V05

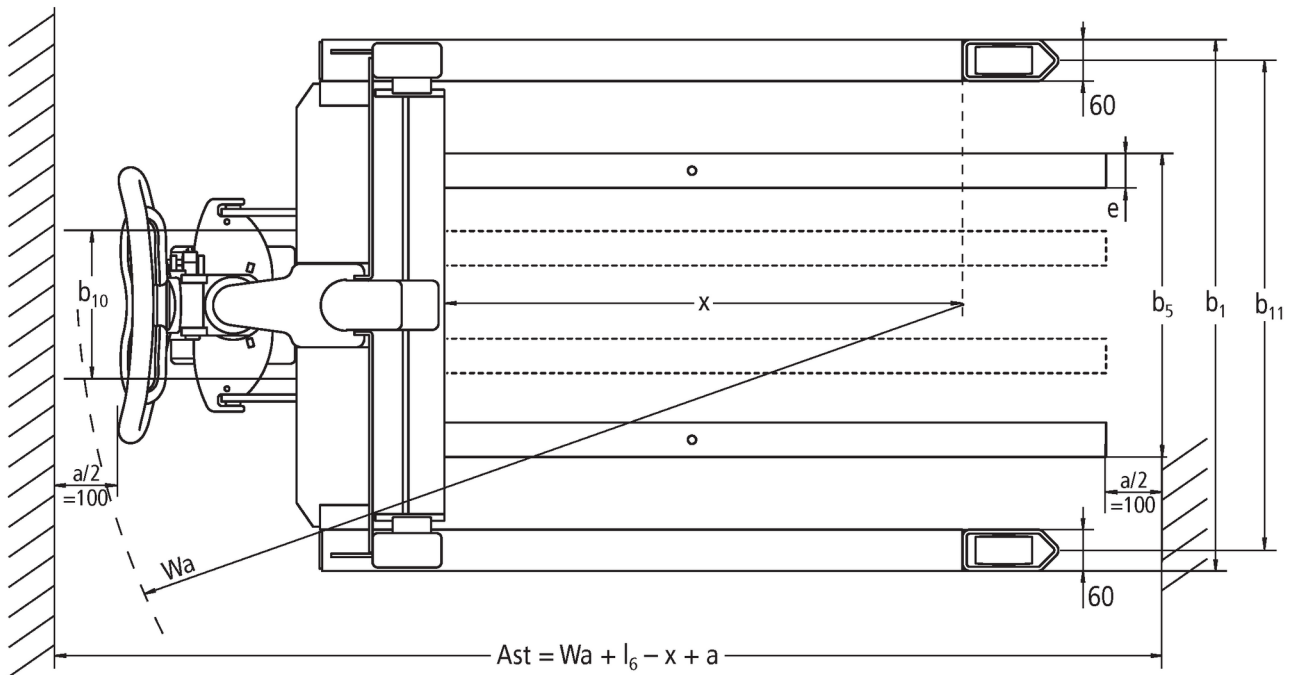

VDI table

Stand-on: 05/2024

Characteristic	1.1	Manufacturer (abbreviated description)		Jungheinrich	
	1.2	Manufacturer's type designation		AM V05	
	1.3	Drive		Manual	
	1.4	Operation		Manual	
	1.5	Load capacity/load	Q	kg	500
	1.6	Load centre distance	c	mm	400
	1.9	Wheelbase	y	mm	1120
Weights	2.1	tare weight		kg	155
	2.2	Axle load laden front/rear		kg	320 / 325
	2.3	Axle load unladen front/rear		kg	101 / 54
Wheels/suspension system	3.1	Tyres			C-GN
	3.2	Tyre size, front			Ø 180 x 50
	3.3	Tyre size, rear			Ø 82 x 40
	3.5	Wheels, number front/back (x=driven)			2/2
	3.6	Tread width, front	b10	mm	122
	3.7	Tread width, rear	b11	mm	700
	Basic dimensions	4.4	Lift (h3)	h3	mm
4.9		Height of tiller handle in drive position min./max.	h14	mm	1210
4.15		Height, lowered	h13	mm	85
4.19		total length	l1	mm	1405
4.20		Length including fork shank	l2	mm	450
4.21.1		total width	b1	mm	760
4.22		Fork dimensions	s/e/l	mm	50 x 50 x 955
4.25		Width across forks	b5	mm	140
4.26		Width between support arms/loading areas	b4	mm	640
4.32		Ground clearance centre of wheelbase	m2	mm	30
4.34.1		Aisle width (pallet 1000x1200 sideways)	Ast	mm	1805
4.34.2		Aisle width (pallet 800x1200 length)	Ast	mm	2005
4.35		Turning radius	Wa	mm	1425
Performance data		5.3	Lowering speed laden/unladen		m/s

- This data sheet according to VDI guideline 2198 only states the technical values of the standard truck. Different tyres, other masts, additional equipment etc. may result in different values.

The German production facilities in
Norderstedt, Moosburg and Landsberg
are certified as well as our Genuine Parts
Center in Kaltenkirchen. ISO 9001
ISO 14001

Jungheinrich fork lift trucks meet
European safety requirements. 

**JUNGHEINRICH**