



## **Electric pallet truck**

### **EJE 114-120**

Lift height: 122 mm / Load capacity: 1400-2000 kg

# EJE 114-120

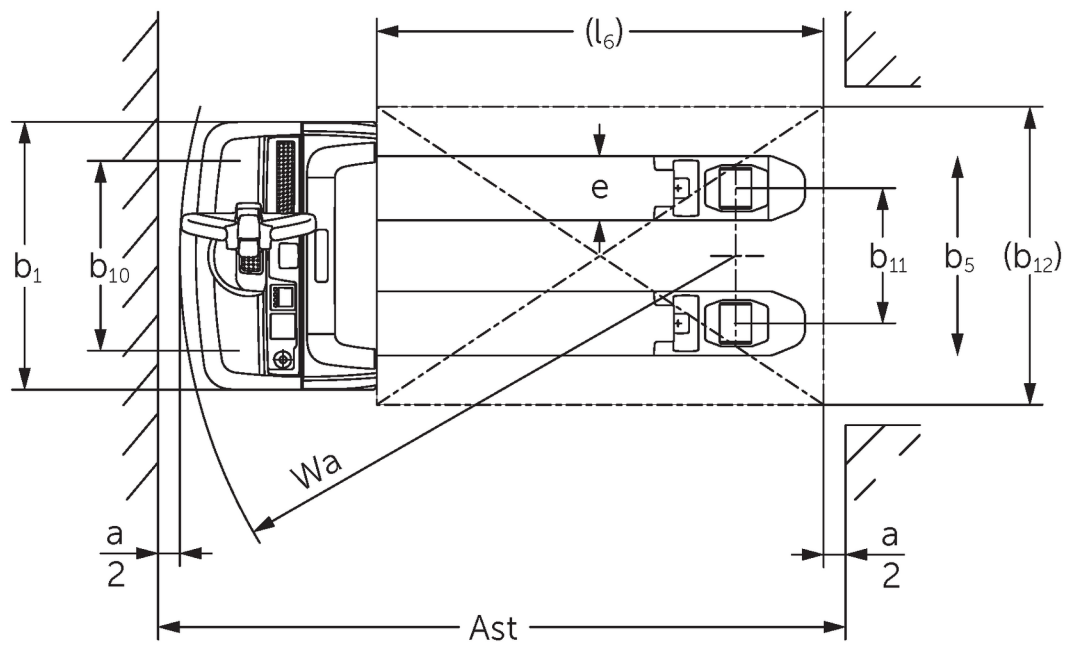

# VDI table

Stand-on: 05/2024

Characteristic	1.1	Manufacturer (abbreviated description)		Jungheinrich			
	1.2	Manufacturer's type designation		<b>EJE 114</b>	<b>EJE 116</b>	<b>EJE 118</b>	<b>EJE 120</b>
	1.3	Drive		Electric			
	1.4	Operation		Pedestrian			
	1.5	Load capacity/load	Q kg	1400	1600	1800	2000
	1.6	Load centre distance	c mm	600			
	1.8	Load distance, centre of drive axle to fork	x mm	908			
	1.9	Wheelbase	y mm	1252			
	Weights	2.1.1	Service weight (incl. battery)	kg	405	420	
2.2		Axle load laden front/rear	kg	655 / 1150	695 / 1325	760 / 1460	785 / 1635
2.3		Axle load unladen front/rear	kg	322 / 83	331 / 89		
Wheels/suspension system	3.1	Tyres		Polyurethane (PU)		-	
	3.2	Tyre size, front		Ø 230 x 70			
	3.3	Tyre size, rear		Ø 85 x 95 / 82 x 70 / 82 x 35	Ø 85 x 110 / 85 x 85 / 85 x 44		
	3.4	Additional wheels		Ø 100 x 40			
	3.5	Wheels, number front/back (x=driven)		1x +2/2 oder 4			
	3.6	Tread width, front	b10 mm	500	510		
	3.7	Tread width, rear	b11 mm	363			
Basic dimensions	4.4	Lift (h3)	h3 mm	122			
	4.9	Height of tiller handle in drive position min./max.	h14 mm	750 / 1237			
	4.15	Height, lowered	h13 mm	85			
	4.19	total length	l1 mm	1636			
	4.20	Length including fork shank	l2 mm	486			
	4.21.1	total width	b1 mm	720			
	4.22	Fork dimensions	s/ e/l mm	55 x 150 x 1150	55 x 172 x 1150		
	4.25	Width across forks	b5 mm	513	535		
	4.32	Ground clearance centre of wheelbase	m2 mm	30			
	4.34.1	Aisle width (pallet 1000x1200 sideways)	Ast mm	2240			
	4.34.2	Aisle width (pallet 800x1200 length)	Ast mm	2128			
4.35	Turning radius	Wa mm	1433				
Performance data	5.1	Travel speed laden/unladen	km/h	5 / 5	6 / 6		
	5.2	Lift speed laden/unladen	m/s	0.03 / 0.03	0.04 / 0.04		
	5.3	Lowering speed laden/unladen	m/s	0.05 / 0.04			
	5.8	Max. gradeability laden/unladen	%	8 / 20	10 / 20	9 / 20	8 / 20
	5.10	Service brake		generative			
E-motor/Electronics	6.1	Drive motor, performance S2 60 min	kW	0.9	1.1		
	6.2	Lift motor, performance with S3	kW	1.2			
	6.3	Battery according to DIN 43531/35/36		B			
	6.4	Battery voltage/nominal capacity	V / Ah	24 / 150			
	6.5	Battery weight	kg	151			
	6.6	Energy consumption according to VDI cycle	kWh/h	0			
	6.6.1	Energy consumption according to EN cycle	kWh/h	0.32	0.31	0.3	0.34
	6.6.2	CO2 equivalent as per EN 16796	kg/h	0.2			
	6.7	Throughput	t/h	67	93	104	117
6.8.1	Energy consumption with max. throughput	kWh/h	0.49	0.66	0.62	0.7	

Other	8.1	Type of drive control		AC
	10.7	Sound level as per EN12053, operator's ear	dB (A)	61
<p>- This data sheet according to VDI guideline 2198 only states the technical values of the standard truck. Different tyres, other masts, additional equipment etc. may result in different values.</p>				

- VDI no. 4.33: lowered load section: + 50 mm
- VDI no. 1.8: 1.9: 4.35: lowered load section: + 56 mm
- VDI no. 4.33.4: lowered load section: + 68 mm
- VDI no. 1.9: 4.19: 4.19.1: 4.20: 4.33: 4.33.4: 4.35: with lateral battery exchange: M = S + 69 mm; L / M LBE = S + 141 mm; L LBE = S + 194 mm

The German production facilities in  
Norderstedt, Moosburg and Landsberg  
are certified as well as our Genuine Parts  
Center in Kaltenkirchen. ISO 9001  
ISO 14001

Jungheinrich fork lift trucks meet  
European safety requirements. 

**JUNGHEINRICH**