



Electric pedestrian stacker with support arm lift

ERC 214zi-216zi

Lift height: 2400-6000 mm / Load capacity: 1400-1600 kg

ERC 214zi-216zi

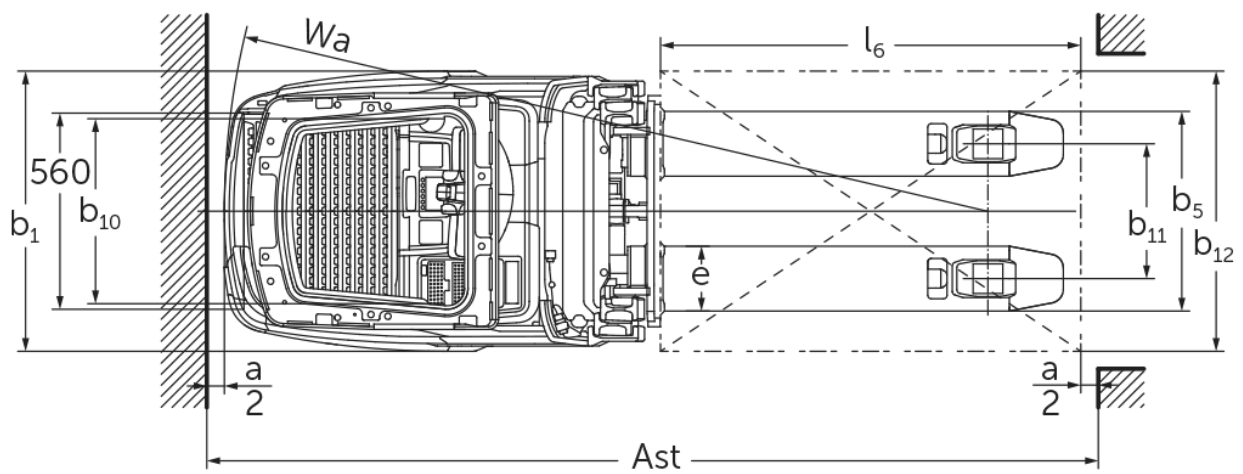

ERC 214zi-216zi

ERC 214zi	Lift (h3)	Retracted mast height (h1)	Free lift (h2)	Extended mast height (h4)
Duplex mast ZT	2500 mm	1800 mm	100 mm	3025 mm
	2760 mm	1930 mm	100 mm	3285 mm
	2900 mm	2000 mm	100 mm	3425 mm
	3160 mm	2130 mm	100 mm	3685 mm
	3600 mm	2350 mm	100 mm	4125 mm
	4100 mm	2600 mm	100 mm	4625 mm
	4300 mm	2700 mm	100 mm	4825 mm
Triplex mast DZ	4090 mm	1880 mm	1348 mm	4622 mm
	4300 mm	1950 mm	1418 mm	4832 mm
	4690 mm	2080 mm	1548 mm	5222 mm
	5350 mm	2300 mm	1768 mm	5882 mm
ERC 214zi, ERC 216zi	Lift (h3)	Retracted mast height (h1)	Free lift (h2)	Extended mast height (h4)
Triplex mast DZ	6000 mm	2550 mm	1968 mm	6582 mm
ERC 216zi	Lift (h3)	Retracted mast height (h1)	Free lift (h2)	Extended mast height (h4)
Duplex mast ZT	2400 mm	1800 mm	100 mm	2975 mm
	2660 mm	1930 mm	100 mm	3235 mm
	2800 mm	2000 mm	100 mm	3375 mm
	3060 mm	2130 mm	100 mm	3635 mm
	3500 mm	2350 mm	100 mm	4075 mm
	4000 mm	2600 mm	100 mm	4575 mm
	4200 mm	2700 mm	100 mm	4775 mm
Triplex mast DZ	3990 mm	1880 mm	1298 mm	4572 mm
	4200 mm	1950 mm	1368 mm	4782 mm
	4590 mm	2080 mm	1498 mm	5172 mm
	5250 mm	2300 mm	1718 mm	5832 mm

VDI table

Stand-on: 05/2024

Characteristic	1.1	Manufacturer (abbreviated description)		Jungheinrich	
	1.2	Manufacturer's type designation		ERC 214zi	ERC 216zi
	1.3	Drive		Electric	
	1.4	Operation		Operator platform	
	1.5	Load capacity/load	Q kg	1400	1600
	1.5.1	Rated capacity/load with mast lift	Q kg	1400	1600
	1.5.2	Rated capacity/load with support arm lift	Q kg	2000	
	1.6	Load centre distance	c mm	600	
	1.8	Load distance, centre of drive axle to fork	x mm	883	
1.9	Wheelbase	y mm	1498		
Weights	2.1.1	Service weight (incl. battery)	kg	1560	1570
	2.2	Axle load laden front/rear	kg	1455 / 1505	1480 / 1690
	2.3	Axle load unladen front/rear	kg	1225 / 355	1230 / 340
Wheels/suspension system	3.1	Tyres		Polyurethane (PU)	
	3.2	Tyre size, front		Ø 230 x 77	
	3.3	Tyre size, rear		Ø 85 x 75	
	3.4	Additional wheels		Ø 140 x 114	
	3.5	Wheels, number front/back (x=driven)		1x + 1 / 4	
	3.6	Tread width, front	b10 mm	535	
	3.7	Tread width, rear	b11 mm	385	
Basic dimensions	4.2	Retracted mast height (h1)	h1 mm	2300	
	4.3	Free lift (h2)	h2 mm	1768	1718
	4.4	Lift (h3)	h3 mm	5350	5250
	4.5	Extended mast height (h4)	h4 mm	5882	5832
	4.6	Initial lift	h5 mm	122	
	4.7	Height of overhead guard (cab)	h6 mm	2300	
	4.9	Height of tiller handle in drive position min./max.	h14 mm	1185 / 1245	
	4.15	Height, lowered	h13 mm	90	
	4.19	total length	l1 mm	2395	
	4.20	Length including fork shank	l2 mm	1245	
	4.21.1	total width	b1 mm	800	
	4.22	Fork dimensions	s/e/ l mm	56 x 185 x 1150	
	4.25	Width across forks	b5 mm	570	
	4.32	Ground clearance centre of wheelbase	m2 mm	18	
	4.34.1	Aisle width (pallet 1000x1200 sideways)	Ast mm	2595	
4.34.2	Aisle width (pallet 800x1200 length)	Ast mm	2645		
4.35	Turning radius	Wa mm	2129		
Performance data	5.1	Travel speed laden/unladen	km/h	9.2 / 12	
	5.2	Lift speed laden/unladen	m/s	0.19 / 0.35	
	5.3	Lowering speed laden/unladen	m/s	0.49 / 0.49	
	5.8	Max. gradeability laden/unladen	%	8 / 16	
	5.10	Service brake		generative	
E-motor/ Electronics	6.1	Drive motor, performance S2 60 min	kW	3.2	
	6.2	Lift motor, performance with S3	kW	3	
	6.3	Battery according to DIN 43531/35/36		Jungheinrich Li-ion	
	6.4	Battery voltage/nominal capacity	V / Ah	24 / 260	
	6.5	Battery weight	kg	98	

	6.6	Energy consumption according to VDI cycle	kWh/h	0	
	6.6.1	Energy consumption according to EN cycle	kWh/h	0.98	
	6.6.2	CO2 equivalent as per EN 16796	kg/h	0.5	
	6.7	Throughput	t/h	75	83
	6.8.1	Energy consumption with max. throughput	kWh/h	1.92	2.14
Other	8.1	Type of drive control		AC	
	10.7	Sound level as per EN12053, operator's ear	dB (A)	68	
<p>- This data sheet according to VDI guideline 2198 only states the technical values of the standard truck. Different tyres, other masts, additional equipment etc. may result in different values.</p>					

The values in the table apply for the 260-Ah Li-ion battery, DZ 5350 / DZ 5250 mast, raised support arms, with overhead guard, without bumper.

- VDI no. 1.5: in double-decker operation (optional): mast lift max. half rated load / overall load max. 2.0 t
- VDI no. 1.5.1: in double-decker operation (optional): mast lift max. half rated load / overall load max. 2.0 t
- VDI no. 1.5.2: in double-decker operation (optional): mast lift max. half rated load / overall load max. 2.0 t
- VDI no. 1.8: with lowered support arms: $x + 51$ mm; with duplex telescopic mast: $x + 32$ mm
- VDI no. 1.9: with lowered support arms: $y + 51$ mm
- VDI no. 4.19: with duplex telescopic mast: $l1 - 32$ mm
- VDI no. 4.20: with duplex telescopic mast: $l2 - 32$ mm
- VDI no. 4.34.1: diagonal as per VDI: aisle width + 345 mm; with duplex telescopic mast: aisle width - 32 mm
- VDI no. 4.34.2: diagonal as per VDI: aisle width + 194 mm; with duplex telescopic mast: aisle width - 32 mm
- VDI no. 4.35: with lowered support arms: $Wa + 51$ mm
- VDI no. 6.2: with $S3 = 11\%$
- VDI no. 6.5: with 130 Ah = 76 kg

The German production facilities in
Norderstedt, Moosburg and Landsberg
are certified as well as our Genuine Parts
Center in Kaltenkirchen. ISO 9001
ISO 14001

Jungheinrich fork lift trucks meet
European safety requirements. 

**JUNGHEINRICH**