

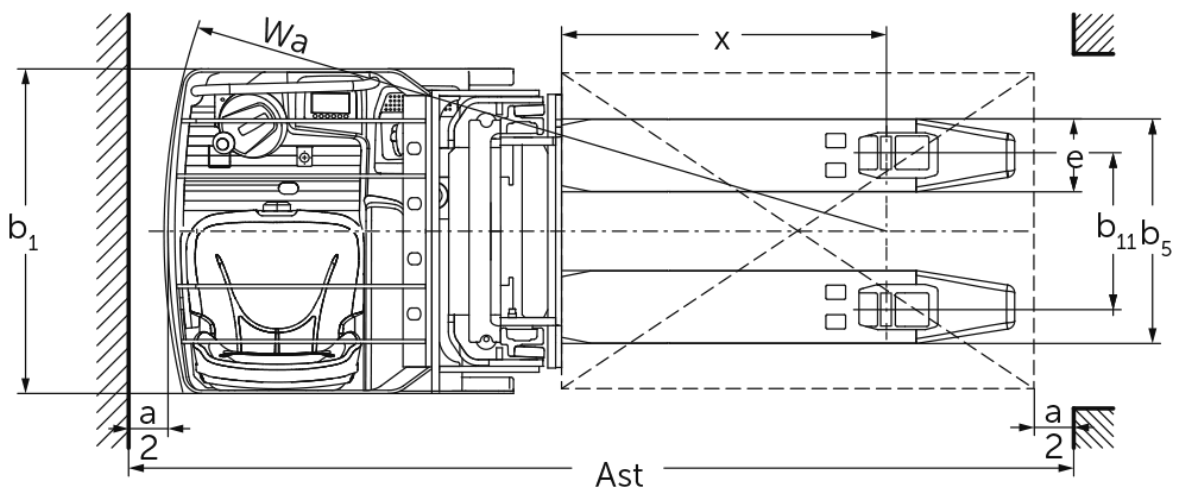

Electric sideways-seated stacker **ESC 214-316 / 214z-316z**

Lift height: 2800-6200 mm / Load capacity: 1400-1600 kg

ESC 214-316 / 214z-316z

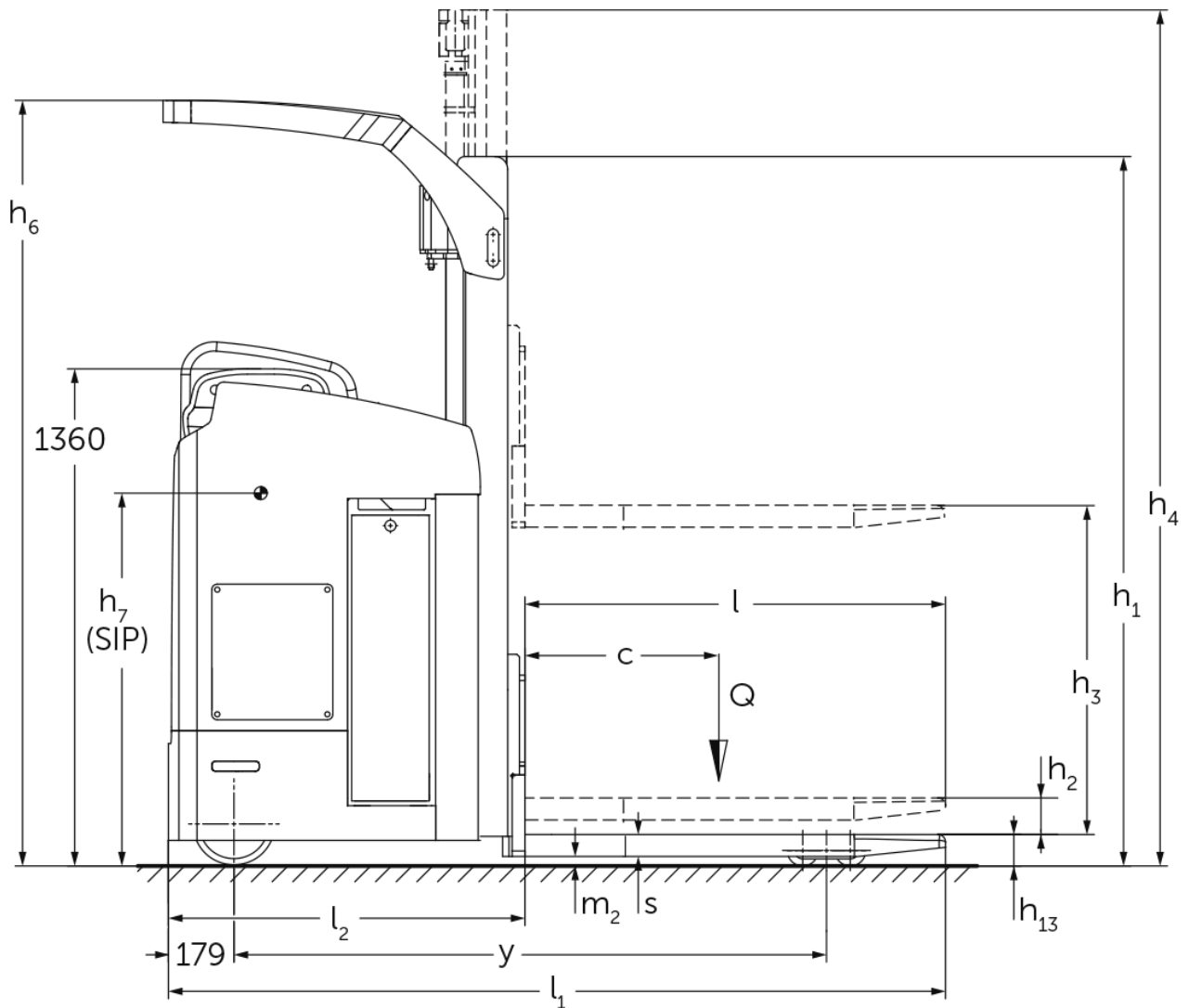

ESC 214-316 / 214z-316z



ESC 214-316 / 214z-316z

ESC 214, ESC 214z	Lift (h3)	Retracted mast height (h1)	Free lift (h2)	Extended mast height (h4)	Height of overhead guard (cab)
Duplex mast ZT	2900 mm	1995 mm	100 mm	3422 mm	2093 mm
	3200 mm	2145 mm	100 mm	3722 mm	2243 mm
	3600 mm	2345 mm	100 mm	4122 mm	2288 mm
	4100 mm	2595 mm	100 mm	4622 mm	2288 mm
	4300 mm	2695 mm	100 mm	4822 mm	2288 mm
Duplex mast ZZ	2900 mm	1945 mm	1420 mm	3422 mm	2093 mm
	3200 mm	2095 mm	1570 mm	3722 mm	2243 mm
	3600 mm	2295 mm	1770 mm	4122 mm	2288 mm
	4100 mm	2545 mm	2020 mm	4622 mm	2288 mm
	4300 mm	2645 mm	2120 mm	4822 mm	2288 mm
Triplex mast DZ	4300 mm	1945 mm	1426 mm	4830 mm	2093 mm
	5350 mm	2295 mm	1776 mm	5880 mm	2288 mm
ESC 216, ESC 216z, ESC 316, ESC 316z	Lift (h3)	Retracted mast height (h1)	Free lift (h2)	Extended mast height (h4)	Height of overhead guard (cab)
Duplex mast ZT	2800 mm	1995 mm	100 mm	3372 mm	2093 mm
	3100 mm	2145 mm	100 mm	3672 mm	2243 mm
	3500 mm	2345 mm	100 mm	4072 mm	2288 mm
	4000 mm	2595 mm	100 mm	4572 mm	2288 mm
	4200 mm	2695 mm	100 mm	4772 mm	2288 mm
Duplex mast ZZ	2800 mm	1945 mm	1373 mm	3372 mm	2093 mm
	3100 mm	2095 mm	1523 mm	3672 mm	2243 mm
	3500 mm	2295 mm	1723 mm	4072 mm	2288 mm
	4000 mm	2545 mm	1973 mm	4572 mm	2288 mm
	4200 mm	2645 mm	2073 mm	4772 mm	2288 mm
Triplex mast DZ	4200 mm	1945 mm	1376 mm	4770 mm	2093 mm
	5250 mm	2295 mm	1726 mm	5820 mm	2288 mm
	6200 mm	2615 mm	2046 mm	6790 mm	2288 mm

VDI table

Stand-on: 05/2024

		Jungheinrich								
		ESC 214	ESC 216	ESC 214z	ESC 216z	ESC 316	ESC 316z			
Characteristic	1.1	Manufacturer (abbreviated description)								
	1.2	Manufacturer's type designation								
	1.3	Drive	Electric							
	1.4	Operation	Seat							
	1.5	Load capacity/load	Q kg	1400	1600	1400	1600			
	1.6	Load centre distance	c mm	600						
	1.8	Load distance, centre of drive axle to fork	x mm	860		874		860	874	
	1.9	Wheelbase	y mm	1656		1685		1656	1700	
	Weights	2.1.1	Service weight (incl. battery)	kg	1590		1660		1746	1685
2.2		Axle load laden front/rear	kg	1316 / 1674	1340 / 1850	1285 / 1775	1370 / 1890	1459 / 1228	1432 / 1857	
2.3		Axle load unladen front/rear	kg	1113 / 477		1162 / 498		1891 / 518	1190 / 495	
Wheels/suspension system	3.1	Tyres	Polyurethane (PU)							
	3.2	Tyre size, front	Ø 230 x 77							
	3.3	Tyre size, rear	Ø 85 x 85							
	3.4	Additional wheels	Ø 140 x 126							
	3.5	Wheels, number front/back (x=driven)	2 + 1x / 4							
	3.6	Tread width, front	b10 mm	544				645		
	3.7	Tread width, rear	b11 mm	385						
Basic dimensions	4.2	Retracted mast height (h1)	h1 mm	1995						
	4.3	Free lift (h2)	h2 mm	100						
	4.4	Lift (h3)	h3 mm	2900	2800	2900	2800			
	4.5	Extended mast height (h4)	h4 mm	3422						
	4.6	Initial lift	h5 mm	-		125		-	125	
	4.7	Height of overhead guard (cab)	h6 mm	2095						
	4.8	Seat height/stand height	h7 mm	1020						
	4.15	Height, lowered	h13 mm	90						
	4.19	total length	l1 mm	2125		2140		2125	2155	
	4.20	Length including fork shank	l2 mm	975		990		975	1005	
	4.21.1	total width	b1 mm	820				930		
	4.22	Fork dimensions	s/ e/l mm	60 x 185 x 1150						
	4.25	Width across forks	b5 mm	570						
	4.32	Ground clearance centre of wheelbase	m2 mm	30		25		30	25	
	4.34.1	Aisle width (pallet 1000x1200 sideways)	Ast mm	-				2353	2383	
	4.34.2	Aisle width (pallet 800x1200 length)	Ast mm	2383		2398		2403	2433	
4.35	Turning radius	Wa mm	1843		1872		1863	1907		
Performance data	5.1	Travel speed laden/unladen	km/h	9.1 / 9.1						
	5.2	Lift speed laden/unladen	m/s	0.15 / 0.24	0.13 / 0.24	0.14 / 0.23		0.13 / 0.24	0.14 / 0.23	
	5.3	Lowering speed laden/unladen	m/s	0.42 / 0.42		0.42 / 0.38		0.42 / 0.42	0.42 / 0.38	
	5.7	Gradeability laden/unladen	%	7 / 12						
	5.10	Service brake		electric						
E- motor/Electronics	6.1	Drive motor, performance S2 60 min	kW	2.8						
	6.2	Lift motor, performance with S3	kW	3						
	6.3	Battery according to DIN 43531/35/36		no						
	6.4	Battery voltage/nominal capacity	V / Ah	24 / 465						
	6.5	Battery weight	kg	380						
	6.6	Energy consumption according to VDI cycle	kWh/h	0				2.5		

	6.6.1	Energy consumption according to EN cycle	kWh/h	0.94	1.02	0.94	1.02	1.04
	6.6.2	CO2 equivalent as per EN 16796	kg/h	0.5				
Other	8.1	Type of drive control		AC				
- This data sheet according to VDI guideline 2198 only states the technical values of the standard truck. Different tyres, other masts, additional equipment etc. may result in different values.								

The values in the table apply for mast ZT 2800 / 2900, lowered support arm lift.

VDI no. 1.8: with ESC 214z / 216z / 316z: raised support arm lift: x - 78 mm.

VDI no. 1.9: with ESC 214z / 216z / 316z: raised support arm lift: y - 78 mm.

VDI no. 4.34.2: diagonal as per VDI: aisle width + 190 mm.

VDI no. 4.35: with ESC 214z / 216z / 316z: raised support arm lift: Wa - 78 mm.

The German production facilities in
Norderstedt, Moosburg and Landsberg
are certified as well as our Genuine Parts
Center in Kaltenkirchen. ISO 9001
ISO 14001

Jungheinrich fork lift trucks meet
European safety requirements. 

 **JUNGHEINRICH**