



Mobile robot automated VNA storage **EKX 514a / 516ka / 516a**

Lift height: 11000-13000 mm / Load capacity: 1400-1600 kg

**JUNGHEINRICH**

EKX 514a / 516ka / 516a

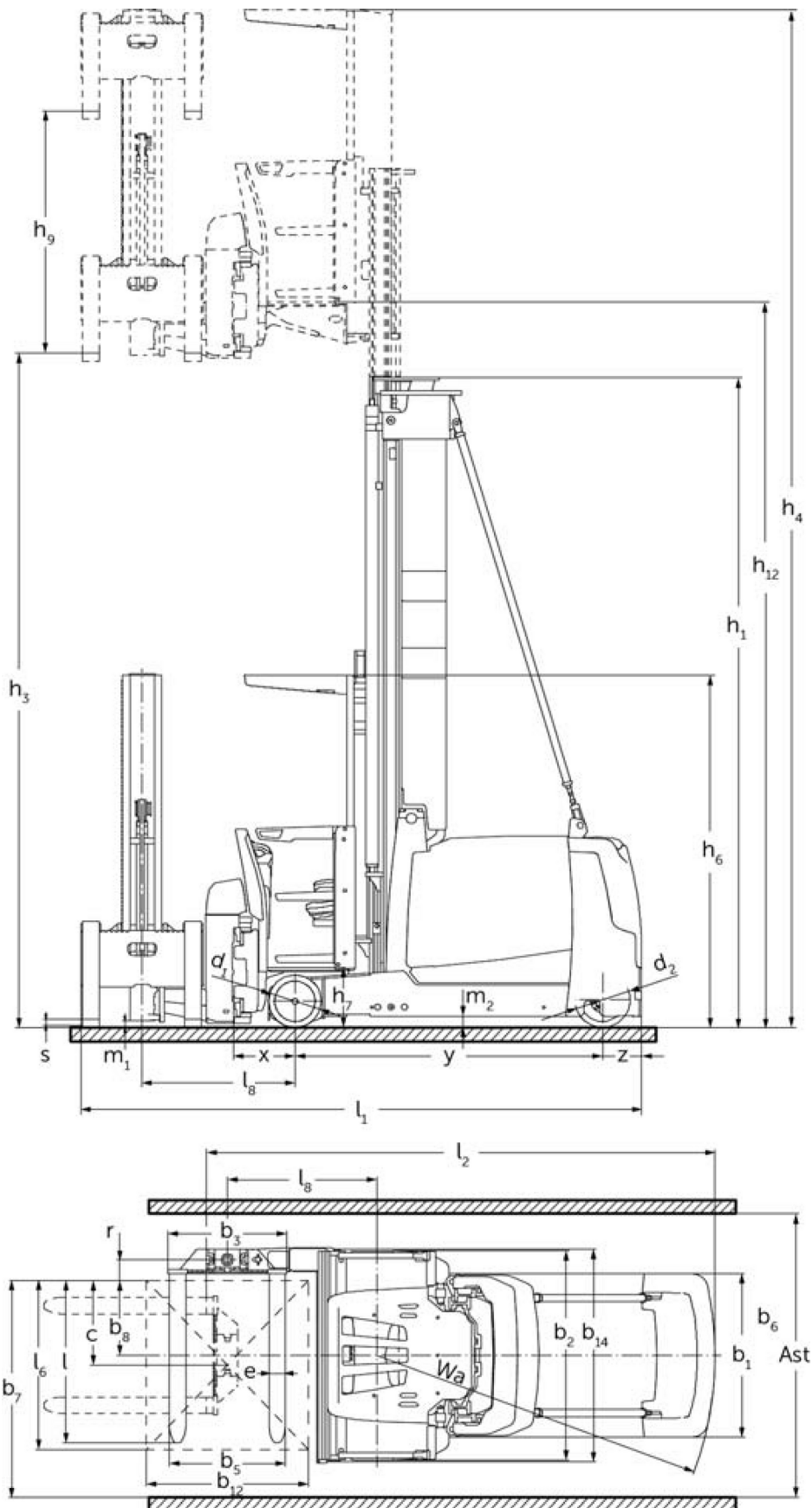

VDI table

Stand-on: 05/2024

Characteristic	1.1	Manufacturer (abbreviated description)		Jungheinrich		
	1.2	Manufacturer's type designation		EKX 514a	EKX 516ka	EKX 516a
	1.3	Drive		Electric		
	1.4	Operation		Automatic		
	1.5	Load capacity/load	Q kg	1400	1600	
	1.6	Load centre distance	c mm	600		
	1.8	Load distance, centre of drive axle to fork	x mm	445		
	1.9	Wheelbase	y mm	1840	1950	2220
	Weights	2.1.1	Service weight (incl. battery)	kg	6350	6750
2.2		Axle load laden front/rear	kg	5720 / 1880	6190 / 2060	6590 / 2810
2.3		Axle load unladen front/rear	kg	3850 / 2500	3980 / 2770	4480 / 3420
Wheels/ suspension system	3.1	Tyres		Besthane		
	3.2	Tyre size, front		Ø 380 x 192		
	3.3	Tyre size, rear		Ø 400 x 160		
	3.5	Wheels, number front/back (x=driven)		2 / 1x		
Basic dimensions	4.2	Retracted mast height (h1)	h1 mm	2955		
	4.4	Lift (h3)	h3 mm	3500		
	4.5	Extended mast height (h4)	h4 mm	6050		
	4.20	Length including fork shank	l2 mm	3379	3489	3759
	4.21.1	total width	b1 mm	1210		
	4.22	Fork dimensions	s/ e/l mm	50 x 120 x 1200		
	4.31	Ground clearance laden under mast	m1 mm	80		
	4.32	Ground clearance centre of wheelbase	m2 mm	80	-	80
Performance data	5.1	Travel speed laden/unladen	km/h	10.5 / 10.5	12 / 12	
	5.10	Service brake		regenerative		
	5.11	Parking brake		Electric sprung-loaded		
E-motor/ Electronics	6.2	Lift motor, performance with S3	kW	25		
	6.3	Battery according to DIN 43531/35/36		3 PzS 465	4 PzS 620	6 PzS 930
	6.4	Battery voltage/nominal capacity	V	80		
	6.5	Battery weight	kg	1238	1558	2178
Other	8.1	Type of drive control		AC synchronous reluctance		
	10.5	Steering version		electric		
	10.7	Sound level as per EN12053, operator's ear	dB (A)	64		

- This data sheet according to VDI guideline 2198 only states the technical values of the standard truck. Different tyres, other masts, additional equipment etc. may result in different values.

The German production facilities in
Norderstedt, Moosburg and Landsberg
are certified as well as our Genuine Parts
Center in Kaltenkirchen. ISO 9001
ISO 14001

**JUNGHEINRICH**