



# Elektrische vierwielheftruck

## EFG BC 316-330

Hefhoogte: 3000-6500 mm / Capaciteit: 1600-3000 kg

**JUNGHEINRICH**

# EFG BC 316-330



# EFG BC 316-330



# EFG BC 316-330

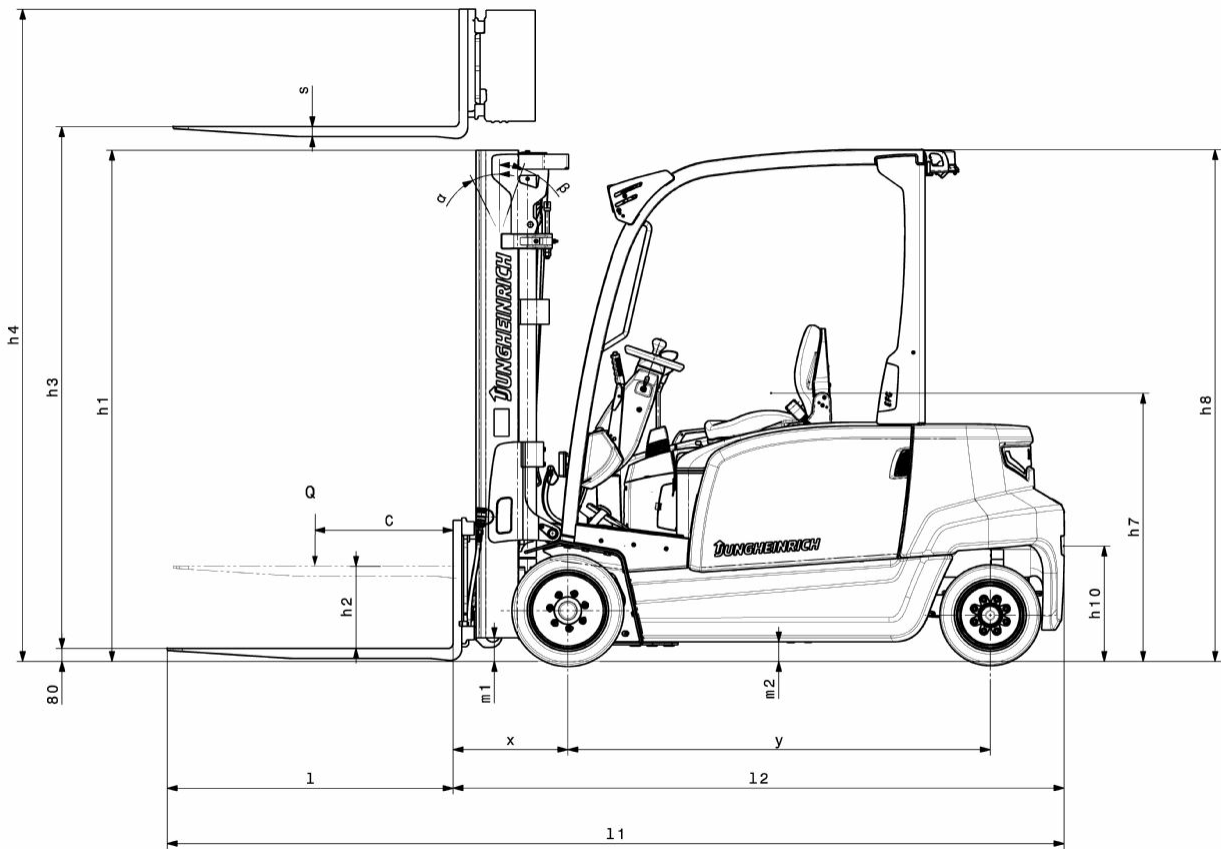

# EFG BC 316-330



# EFG BC 316-330



# EFG BC 316-330

EFG BC 316	Heffing (h3)	Ingeschoven masthoogte (h1)	Vrije heffing (h2)	Uitgeschoven masthoogte (h4)	Neiging mast voorover/achterover
Drievoudige mast DZ	4500 mm	2005 mm	1360 mm	5055 mm	7 / 5 °
	4800 mm	2105 mm	1460 mm	5355 mm	7 / 5 °
	5000 mm	2180 mm	1530 mm	5555 mm	7 / 5 °
	5500 mm	2355 mm	1710 mm	6055 mm	7 / 5 °
	6000 mm	2555 mm	1910 mm	6555 mm	7 / 5 °
	6500 mm	2805 mm	2160 mm	7055 mm	7 / 5 °
Tweevoudige mast ZT	3000 mm	2000 mm	150 mm	3555 mm	7 / 5 °
	3300 mm	2150 mm	150 mm	3855 mm	7 / 5 °
	3600 mm	2300 mm	150 mm	4155 mm	7 / 5 °
	4000 mm	2500 mm	150 mm	4555 mm	7 / 5 °
	4500 mm	2800 mm	150 mm	5055 mm	7 / 5 °
	5000 mm	3050 mm	150 mm	5555 mm	7 / 5 °
Tweevoudige mast ZZ	3300 mm	2105 mm	1470 mm	3855 mm	7 / 5 °
	3600 mm	2255 mm	1620 mm	4155 mm	7 / 5 °
	4000 mm	2455 mm	1820 mm	4555 mm	7 / 5 °
EFG BC 320	Heffing (h3)	Ingeschoven masthoogte (h1)	Vrije heffing (h2)	Uitgeschoven masthoogte (h4)	Neiging mast voorover/achterover
Drievoudige mast DZ	4500 mm	2005 mm	1360 mm	5135 mm	7 / 5 °
	4800 mm	2105 mm	1460 mm	5435 mm	7 / 5 °
	5000 mm	2180 mm	1530 mm	5635 mm	7 / 5 °
	5500 mm	2355 mm	1710 mm	6135 mm	7 / 5 °
	6000 mm	2555 mm	1910 mm	6635 mm	7 / 5 °
	6500 mm	2805 mm	2160 mm	7135 mm	7 / 5 °
Tweevoudige mast ZT	3000 mm	2000 mm	150 mm	3605 mm	7 / 5 °
	3300 mm	2150 mm	150 mm	3905 mm	7 / 5 °
	3600 mm	2300 mm	150 mm	4205 mm	7 / 5 °
	4000 mm	2500 mm	150 mm	4605 mm	7 / 5 °
	4500 mm	2800 mm	150 mm	5105 mm	7 / 5 °
	5000 mm	3050 mm	150 mm	5605 mm	7 / 5 °
Tweevoudige mast ZZ	3300 mm	2105 mm	1470 mm	3935 mm	7 / 5 °
	3600 mm	2255 mm	1620 mm	4235 mm	7 / 5 °
	4000 mm	2455 mm	1820 mm	4635 mm	7 / 5 °
EFG BC 325k, EFG BC 325	Heffing (h3)	Ingeschoven masthoogte (h1)	Vrije heffing (h2)	Uitgeschoven masthoogte (h4)	Neiging mast voorover/achterover
Drievoudige mast DZ	4400 mm	2060 mm	1500 mm	5000 mm	7 / 5 °
	4700 mm	2160 mm	1600 mm	5300 mm	7 / 5 °
	5000 mm	2260 mm	1700 mm	5600 mm	7 / 5 °
Tweevoudige mast ZT	3100 mm	2200 mm	150 mm	3700 mm	7 / 5 °
	3300 mm	2300 mm	150 mm	3900 mm	7 / 5 °
	3500 mm	2400 mm	150 mm	4100 mm	7 / 5 °
	3700 mm	2500 mm	150 mm	4300 mm	7 / 5 °
	4000 mm	2650 mm	150 mm	4600 mm	7 / 5 °
	4500 mm	2950 mm	150 mm	5100 mm	7 / 5 °
Tweevoudige mast ZZ	3100 mm	2160 mm	1600 mm	3700 mm	7 / 5 °

	3300 mm	2260 mm	1700 mm	3900 mm	7 / 5 °
	3500 mm	2360 mm	1800 mm	4100 mm	7 / 5 °
	4000 mm	2610 mm	2060 mm	4600 mm	7 / 5 °
<b>EFG BC 330</b>	<b>Heffing (h3)</b>	<b>Ingeschoven masthoogte (h1)</b>	<b>Vrije heffing (h2)</b>	<b>Uitgeschoven masthoogte (h4)</b>	<b>Neiging mast voorover/achterover</b>
<b>Drievoudige mast DZ</b>	<b>4400 mm</b>	<b>2060 mm</b>	<b>1340 mm</b>	<b>5150 mm</b>	<b>7 / 5 °</b>
	4700 mm	2160 mm	1440 mm	5450 mm	7 / 5 °
	5000 mm	2260 mm	1540 mm	5750 mm	7 / 5 °
<b>Tweevoudige mast ZT</b>	<b>3100 mm</b>	<b>2200 mm</b>	<b>150 mm</b>	<b>3850 mm</b>	<b>7 / 5 °</b>
	3300 mm	2300 mm	150 mm	4050 mm	7 / 5 °
	3500 mm	2400 mm	150 mm	4250 mm	7 / 5 °
	3700 mm	2500 mm	150 mm	4450 mm	7 / 5 °
	4000 mm	2650 mm	150 mm	4750 mm	7 / 5 °
	4500 mm	2950 mm	150 mm	5250 mm	7 / 5 °
<b>Tweevoudige mast ZZ</b>	<b>3100 mm</b>	<b>2160 mm</b>	<b>1440 mm</b>	<b>3850 mm</b>	<b>7 / 5 °</b>
	3300 mm	2260 mm	1540 mm	4050 mm	7 / 5 °
	3500 mm	2360 mm	1640 mm	4250 mm	7 / 5 °
	4000 mm	2610 mm	1900 mm	4750 mm	7 / 5 °



# VDI-tabel

Stand: 05/2024

			Jungheinrich					
			EFG BC 316	EFG BC 320	EFG BC 325k	EFG BC 325	EFG BC 330	
Kenmerken	1.1	Fabrikant (korte naam)						
	1.2	Typeaanduiding fabrikant						
	1.3	Aandrijving	Elektrisch					
	1.4	Bediening	Stoel					
	1.5	Capaciteit/last	Q kg	1600	2000	2500	3000	
	1.6	Lastzwaartepuntafstand	c mm	500				
	1.8	Lastafstand	x mm	352		467	472	
	1.9	Wielbasis	y mm	1506		1453	1561	1700
	Gewichten	2.1.1	Eigen gewicht (incl. accu)	kg	3230	3317	4351	4454
2.2		Aslast met last voor/achter	kg	4012 / 818	4738 / 579	6166 / 685	6259 / 695	6968 / 774
2.3		Aslast onbelast voor/achter	kg	1514 / 1716	1606 / 1711	1833 / 2518	1960 / 2494	2225 / 2517
Wielen/chassis	3.1	Banden	SuperElastik (SE)					
	3.2	Bandenmaat, voor	18 x 7 - 8	200 / 50 - 10	18 x 9 - 12		TANDEM, 18 x 5 & 6 - 12(1/8)	
	3.3	Bandenmaat, achter	16 x 6 - 8		16 x 6 -10 (1/2)		16 x 7 -10 (1/2)	
	3.5	Wielen, aantal voor/achter (x = aangedreven)	2x / 2					
	3.6	Spoorbreedte, voor	b10 mm	904	924	938	1013	
	3.7	Spoorbreedte, achter	b11 mm	870		864	995	
	Afmetingen	4.1	Neiging mast voorover/achterover	a/B °	7 / 5			
4.2		Ingeschoven masthoogte (h1)	h1 mm	2000		2200		
4.2.1		Totale hoogte	h15 mm	2080		2200		
4.3		Vrije heffing (h2)	h2 mm	150				
4.4		Heffing (h3)	h3 mm	3000		3100		
4.5		Uitgeschoven masthoogte (h4)	h4 mm	3555	3605	3700	3850	
4.7		Hoogte beschermend dak (cabine)	h6 mm	2080				
4.8		Zithoogte / stahoogte	h7 mm	1030				
4.12		Koppelingshoogte	h10 mm	475				
4.19		Totale lengte	l1 mm	3096		3213	3321	3469
4.20		Lengte inclusief vorkrug	l2 mm	2096		2213	2321	2469
4.21.1		Totale breedte	b1 mm	1060	1120	1170		1313
4.22		Vorkafmetingen	s/ e/l mm	40 x 100 x 1000				45 x 125 x 1000
4.23		Vorkenbord aansluitklasse		2A			3A	
4.24		Breedte vorkenbord	b3 mm	980		1120		
4.31		Bodemvrijheid met last onder hefmast	m1 mm	97				
4.32		Bodemvrijheid midden wielbasis	m2 mm	88				
4.34.1		Werkbreedte (pallet 1000 x 1200 dwars)	Ast mm	3513		3608	3727	3897
4.34.2		Werkbreedte (pallet 800x1200 longitudinaal)	Ast mm	3712		3807	3927	4097
4.35		Draaicirkel	Wa mm	1960		1940	2060	2225
4.36	Kleinste draaipuntafstand	b13 mm	562		542	600	667	
Prestaties	5.1	Rijsnelheid met last/onbelast	km/u	15 / 15		17 / 18		
	5.2	Hefsnelheid met last/onbelast	m/s	0,43 / 0,53	0,34 / 0,44	0,4 / 0,5		0,3 / 0,32
	5.3	Daalsnelheid met last/onbelast	m/s	0,51 / 0,55				
	5.5	Trekkracht met last	N	1300	1600	2400		2300
	5.6	Max. trekkracht met last/onbelast	N	9000 / 9400	9200 / 10500	14000 / 8700		13800 / 14600

	5.7	Nominale helling met last/onbelast	%	6,5 / 14	5 / 11	9 / 13	8 / 12
	5.8	Max. helling met last/onbelast	%	13,5 / 16	11 / 15	16 / 22	15 / 22
	5.9	Acceleratietijd met last/onbelast	s	5,5 / 5	6 / 5,2	5,6 / 5	5,7 / 5,2
	5.10	Rem		mechanisch/hydraulisch			
E-motor/elektronica	6.1	Rijmotor, vermogen S2 60 min	kW	3,7		4,6	
	6.1.1	2. Rijmotor, vermogen S2 60 min	kW	3,7		4,6	
	6.2	Hefmotor, vermogen bij S3	kW	10		15,5	
	6.3	Accu volgens DIN 43531/35/36		DIN 43531 A			
	6.4	Accuspanning/nominaal vermogen	V / Ah	48 / 625		48 / 750	
	6.5	Accugewicht	kg	856		1013	
	6.6.1	Energieverbruik volgens EN-cyclus	kWh/u	4,25	4,8	5,77	6,88
	6.6.2	CO2-equivalent volgens EN16796	kg/h	2,3	2,6	3,1	3,7
	6.7	Omslag	t/h	113	136	172	196
	6.8.1	Energieverbruik bij max. omslag	kWh/u	5,13	5,88	8,84	7,71
Overig	8.1	Type rijregeling		Inputs/AC			
	10.1	Werkdruk voor aanbouwapparaat	bar	230			
	10.2	Oliestroom voor aanbouwapparatuur	l/min	24		41	
	10.7	Geluidsdruk niveau volgens EN12053, stuurhuis	dB (A)	74		78	
	10.8	Trekhaak, type / type DIN		Pen			
- Dit typeblad volgens VDI-richtlijn 2198 noemt alleen de technische waarden van de standaardmachine. Afwijkende banden, andere hefmasten, extra systemen etc. kunnen resulteren in andere waarden.							

De Duitse fabrieken in Norderstedt,  
Moosburg en Landsberg zijn  
gecertificeerd, evenals ons  
onderdelenmagazijn in Kaltenkirchen.

ISO 9001  
ISO 14001

Jungheinrich intern transport materieel  
voldoet aan de Europese  
veiligheidsvoorschriften.



 **JUNGHEINRICH**

The logo features a red upward-pointing arrow integrated into the letter 'J' of the word 'JUNGHEINRICH', which is written in a bold, black, sans-serif font.