

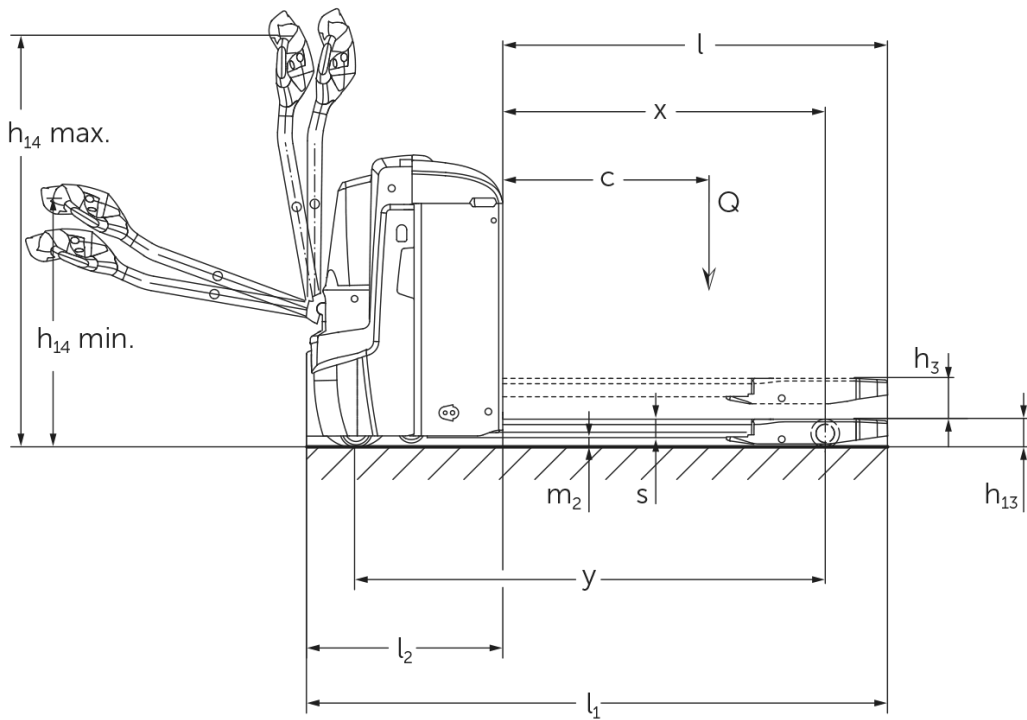

## **Electric pedestrian pallet truck** **EJE 222 / 225 / 230 / 235**

Lift height: 122 mm / Load capacity: 2200-3500 kg

# EJE 222 / 225 / 230 / 235



# VDI table

Stand-on: 07/2024

Characteristic	Item	Description	Unit	Jungheinrich			
				EJE 222	EJE 225	EJE 230	EJE 235
Characteristic	1.1	Manufacturer (abbreviated description)					
	1.2	Manufacturer's type designation					
	1.3	Drive		Electric			
	1.4	Operation		Pedestrian			
	1.5	Load capacity/load	Q kg	2200	2500	3000	3500
	1.6	Load centre distance	c mm	600			
	1.8	Load distance, centre of drive axle to fork	x mm	908		909	
	1.9	Wheelbase	y mm	1351		1352	
	Weights	2.1.1	Service weight (incl. battery)	kg	535		565
2.2		Axle load laden front/rear	kg	879 / 1870	970 / 2072	1116 / 2449	1230 / 2833
2.3		Axle load unladen front/rear	kg	408 / 127		430 / 135	
Wheels/suspension system	3.1	Tyres		-		Polyurethane (PU)	
	3.2	Tyre size, front		Ø 230 x 70			
	3.3	Tyre size, rear		Ø 85 x 110		Ø 85 x 85	
	3.4	Additional wheels		Ø 100 x 40			
	3.5	Wheels, number front/back (x=driven)		1x +2 / 2		1x +2 / 4	
	3.6	Tread width, front	b10 mm	510			
	3.7	Tread width, rear	b11 mm	363			
Basic dimensions	4.4	Lift (h3)	h3 mm	122			
	4.9	Height of tiller handle in drive position min./max.	h14 mm	750 / 1237			
	4.15	Height, lowered	h13 mm	85			
	4.19	total length	l1 mm	1737			
	4.20	Length including fork shank	l2 mm	587			
	4.21.1	total width	b1 mm	724			
	4.22	Fork dimensions	s/ e/l mm	55 x 172 x 1150			
	4.25	Width across forks	b5 mm	535			
	4.32	Ground clearance centre of wheelbase	m2 mm	30			
	4.34.1	Aisle width (pallet 1000x1200 sideways)	Ast mm	2338			
	4.34.2	Aisle width (pallet 800x1200 length)	Ast mm	2227			
4.35	Turning radius	Wa mm	1532				
Performance data	5.1	Travel speed laden/unladen	km/h	6 / 6			4 / 6
	5.2	Lift speed laden/unladen	m/s	0.05 / 0.07		0.04 / 0.07	
	5.3	Lowering speed laden/unladen	m/s	0.05 / 0.04		0.06 / 0.04	
	5.8	Max. gradeability laden/unladen	%	8 / 20		6 / 20	5 / 20
	5.10	Service brake		generative			
E-motor/Electronics	6.1	Drive motor, performance S2 60 min	kW	1.7			
	6.2	Lift motor, performance with S3	kW	2.2			
	6.3	Battery according to DIN 43531/35/36		B			
	6.4	Battery voltage/nominal capacity	V / Ah	24 / 250			
	6.5	Battery weight	kg	220			
	6.6	Energy consumption according to VDI cycle	kWh/h	0			
	6.6.1	Energy consumption according to EN cycle	kWh/h	0.35	0.37	0.38	0.4
	6.6.2	CO2 equivalent as per EN 16796	kg/h	0.2			
	6.7	Throughput	t/h	123	148	175	205
6.8.1	Energy consumption with max. throughput	kWh/h	0.77	0.82	0.98	1.14	

Other	8.1	Type of drive control		AC
	10.7	Sound level as per EN12053, operator's ear	dB (A)	70
<p>- This data sheet according to VDI guideline 2198 only states the technical values of the standard truck. Different tyres, other masts, additional equipment etc. may result in different values.</p>				

- 4.33: lowered load section: + 50 mm
- 1.8: 1.9: 4.35: lowered load section: + 56 mm
- 4.34: lowered load section: + 25 mm
- 1.9: 4.19: 4.19.1: 4.20: 4.33: 4.34: 4.35: with lateral battery exchange: L / M LBE = M + 72 mm; L LBE = M + 125 mm
- 5.1: up to a load of 3 t: max. travel speed = 6 km/h.

The German production facilities in  
Norderstedt, Moosburg and Landsberg  
are certified as well as our Genuine Parts  
Center in Kaltenkirchen. ISO 9001  
ISO 14001

Jungheinrich fork lift trucks meet  
European safety requirements. 

**JUNGHEINRICH**