



Electric ride-on/pedestrian pallet truck

ERE 120-230

Lift height: 122 mm / Load capacity: 2000-3000 kg

ERE 120-230



ERE 120-230

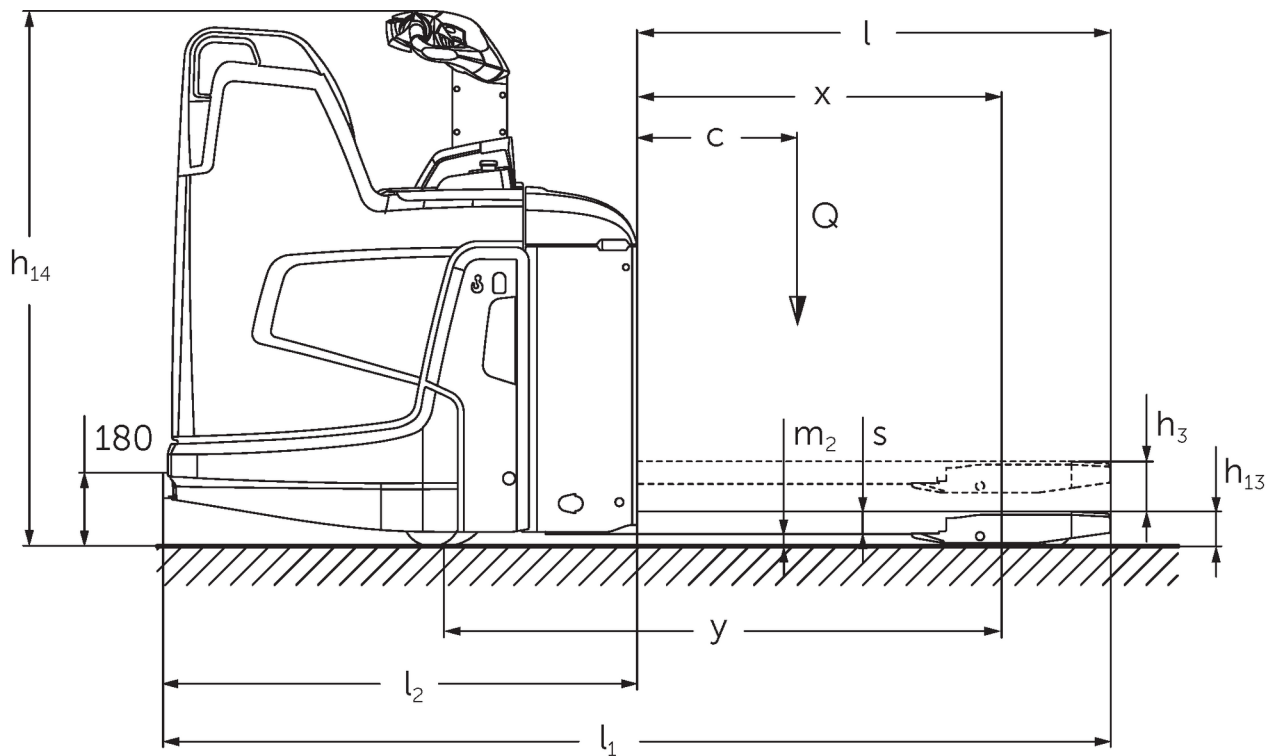

VDI table

Stand-on: 07/2024

Characteristic	1.1	Manufacturer (abbreviated description)	Jungheinrich									
			ERE 120 6km/h	ERE 120 9 km/h	ERE 125	ERE 225	ERE 225 drivePLUS	ERE 230	ERE 230 drivePLUS			
Characteristic	1.2	Manufacturer's type designation										
	1.3	Drive	Electric									
	1.4	Operation	Tiller									
	1.5	Load capacity/load	Q kg	2000		2500		3000				
	1.6	Load centre distance	c mm	600								
	1.8	Load distance, centre of drive axle to fork	x mm	908								
	1.9	Wheelbase	y mm	1378				1450				
	Weights	2.1	tare weight	kg	400		404		424			
		2.1.1	Service weight (incl. battery)	kg	-							
2.2		Axle load laden front/rear	kg	1825 / 795		2090 / 1126		2494 / 1239				
2.3		Axle load unladen front/rear	kg	138 / 474		159 / 550		160 / 565				
Wheels/suspension system	3.1	Tyres	Vulkollan ®/PU + quartz/Vulkollan ®									
	3.2	Tyre size, front	Ø 230 x 65		Ø 230 x 77							
	3.3	Tyre size, rear	Ø 85 x 110 / Ø 85 x 85				Ø 85 x 85					
	3.4	Additional wheels	Ø 140 x 57									
	3.5	Wheels, number front/back (x=driven)	1x +2/2 oder 4				1x +2/4					
	3.6	Tread width, front	b10 mm	363								
	3.7	Tread width, rear	b11 mm	512								
Basic dimensions	4.4	Lift (h3)	h3 mm	122								
	4.9	Height of tiller handle in drive position min./max.	h14 mm	1137 / 1419								
	4.15	Height, lowered	h13 mm	85								
	4.19	total length	l1 mm	1847						1919		
	4.20	Length including fork shank	l2 mm	697						769		
	4.21.1	total width	b1 mm	770								
	4.22	Fork dimensions	s/ e/l mm	55 x 172 x 1150								
	4.25	Width across forks	b5 mm	535								
	4.32	Ground clearance centre of wheelbase	m2 mm	30								
	4.34.1	Aisle width (pallet 1000x1200 sideways)	Ast mm	2411				2483				
	4.34.2	Aisle width (pallet 800x1200 length)	Ast mm	2299				2372				
	4.34.8	Aisle width (pallet 800x1200 crosswise)	Ast mm	2414				2486				
	4.35	Turning radius	Wa mm	1604				1677				
Performance data	5.1	Travel speed laden/unladen	km/h	6 / 6	8 / 9	9 / 9	9.5 / 12.5	9.5 / 14	6 / 12.5	6 / 14		
	5.2	Lift speed laden/unladen	m/s	0.04 / 0.04		0.05 / 0.07						
	5.3	Lowering speed laden/unladen	m/s	0.05 / 0.04		0.05 / 0.05						
	5.8	Max. gradeability laden/unladen	%	5 / 7	8 / 16				6 / 16			
	5.10	Service brake	generative									
E-motor/ Electronics	6.1	Drive motor, performance S2 60 min	kW	2		2.8		3.2		2.8		3.2
	6.2	Lift motor, performance with S3	kW	1.2		2.2						

	6.3	Battery according to DIN 43531/35/36		B	-					B
	6.4	Battery voltage/nominal capacity	V / Ah	24 / 250					24 / 375	
	6.5	Battery weight	kg	230					297	
	6.6.1	Energy consumption according to EN cycle	kWh/h	0.4	0.43	0.4	0.35	0.39	0.36	0.41
	6.6.2	CO2 equivalent as per EN 16796	kg/h	0.2						
	6.7	Throughput	t/h	114	142	156	184	222	220	266
	6.8.1	Energy consumption with max. throughput	kWh/h	0.74	1.11	1.18	1.29	1.89	1.45	2.05
Other	8.1	Type of drive control		AC						
	10.7	Sound level as per EN12053, operator's ear	dB (A)	63			64	67	64	67
<p>- This data sheet according to VDI guideline 2198 only states the technical values of the standard truck. Different tyres, other masts, additional equipment etc. may result in different values.</p>										

The values in the table apply to the folding stand-on platform (folded up), M-LBE battery compartment, fork length 1,150 mm, raised support arm lift.

- VDI no. 1.8: lowered load section: x + 56 mm.
 - VDI no. 1.9: lowered load section: y + 56 mm. With M-VBE, L-LBE & L high-LBE battery compartment: y + 72 mm; L-VBE: y + 125 mm.
 - VDI no. 2.1: with lateral battery exchange: + 25 kg.
 - VDI no. 4.19: with M-VBE, L-LBE & L high-LBE battery compartment: l1 + 72 mm; L-VBE: l1 + 125 mm. With folding platform folded down: l1 + 416 mm; compact, fixed platform: l1 + 357 mm; extended, fixed platform: l1 + 472 mm; L platform: l1 + 477 mm.
 - VDI no. 4.20: with M-VBE, L-LBE & L high-LBE battery compartment: l2 + 72 mm; L-VBE: l2 + 125 mm. With folding platform folded down: l2 + 416 mm; compact, fixed platform: l2 + 357 mm; extended, fixed platform: l2 + 472 mm; L platform: l2 + 477 mm.
 - VDI no. 4.34.1: lowered load section: aisle width + 50 mm. with folding platform folded down: aisle width + 416 mm; compact, fixed platform: aisle width + 357 mm; extended, fixed platform: aisle width + 472 mm; L platform: aisle width + 477 mm.
 - VDI no. 4.34.2: with folding platform folded down: aisle width + 416 mm; compact, fixed platform: aisle width + 357 mm; extended, fixed platform: aisle width + 472 mm; L platform: aisle width + 477 mm.
 - VDI no. 4.34.8: lowered load section: aisle width + 68 mm. with folding platform folded down: aisle width + 416 mm; compact, fixed platform: aisle width + 357 mm; extended, fixed platform: aisle width + 472 mm; L platform: aisle width + 477 mm.
 - VDI no. 4.35: lowered load section: Wa + 56 mm.
- With M-VBE, L-LBE & L high-LBE battery compartment: Wa + 72 mm; L-VBE: Wa + 125 mm. with folding platform folded down: Wa + 416 mm; compact, fixed platform: Wa + 357 mm; extended, fixed platform: Wa + 472 mm; L platform: Wa + 477 mm.
- VDI no. 5.1: ERE 230: 9.5 km/h with 2.5 t load.

The German production facilities in
Norderstedt, Moosburg and Landsberg
are certified as well as our Genuine Parts
Center in Kaltenkirchen. ISO 9001
ISO 14001

Jungheinrich fork lift trucks meet
European safety requirements. 

 **JUNGHEINRICH**