



Electric ride-on/pedestrian pallet truck

ERE 225i

Lift height: 122 mm / Load capacity: 2500 kg

ERE 225i

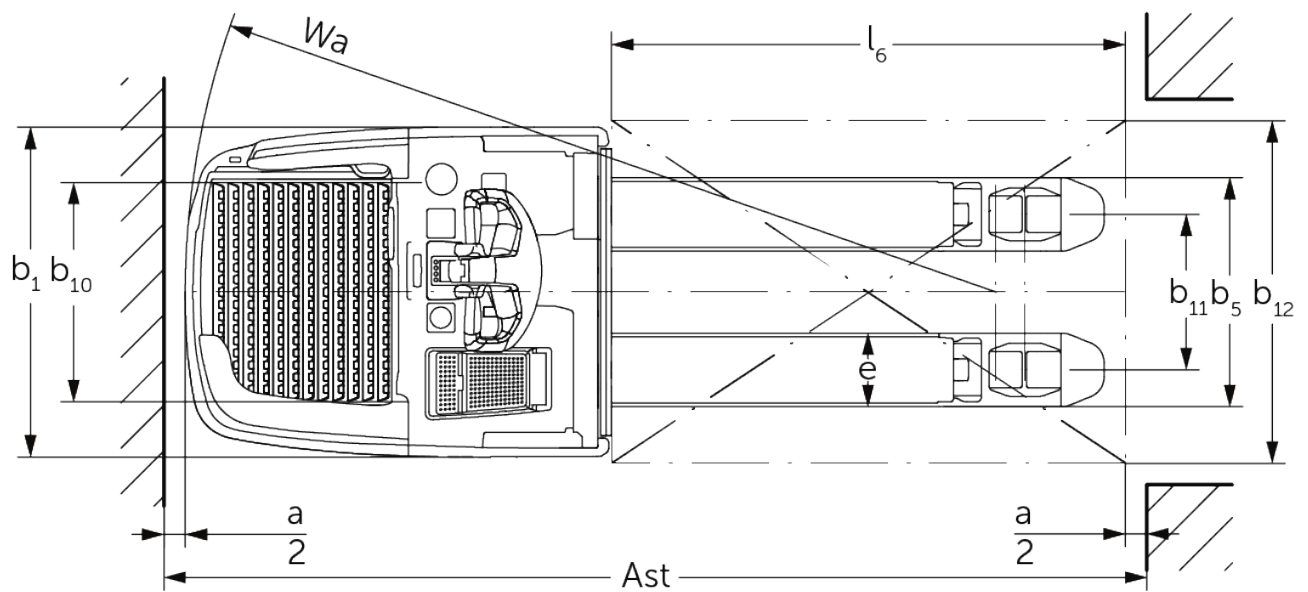

VDI table

Stand-on: 07/2024

Characteristic	1.1	Manufacturer (abbreviated description)		Jungheinrich
	1.2	Manufacturer's type designation		ERE 225i
	1.3	Drive		Electric
	1.4	Operation		Tiller
	1.5	Load capacity/load	Q kg	2500
	1.6	Load centre distance	c mm	600
	1.8	Load distance, centre of drive axle to fork	x mm	898
	1.9	Wheelbase	y mm	1255
	Weights	2.1.1	Service weight (incl. battery)	kg
2.2		Axle load laden front/rear	kg	1390 / 1920
2.3		Axle load unladen front/rear	kg	670 / 140
Wheels/suspension system	3.1	Tyres		Polyurethane (PU)
	3.2	Tyre size, front		ø 230 x 77
	3.3	Tyre size, rear		ø 85 x 110 / ø 85 x 85
	3.4	Additional wheels		ø 140 x 57
	3.5	Wheels, number front/back (x=driven)		1x + 2 / 2 oder 4
	3.6	Tread width, front	b10 mm	512
	3.7	Tread width, rear	b11 mm	363
Basic dimensions	4.4	Lift (h3)	h3 mm	120
	4.9	Height of tiller handle in drive position min./max.	h14 mm	1215 / 1275
	4.15	Height, lowered	h13 mm	85
	4.19	total length	l1 mm	2139
	4.20	Length including fork shank	l2 mm	989
	4.21.1	total width	b1 mm	770
	4.22	Fork dimensions	s/e/l mm	56 x 172 x 1150
	4.25	Width across forks	b5 mm	535
	4.32	Ground clearance centre of wheelbase	m2 mm	18
	4.34.1	Aisle width (pallet 1000x1200 sideways)	Ast mm	2346
	4.34.2	Aisle width (pallet 800x1200 length)	Ast mm	2396
	4.35	Turning radius	Wa mm	1894
Performance data	5.1	Travel speed laden/unladen (Efficiency drivePLUS)	km/h	9 / 12 9 / 14
	5.2	Lift speed laden/unladen	m/s	0.05 / 0.07
	5.3	Lowering speed laden/unladen	m/s	0.12 / 0.05
	5.7	Gradeability laden/unladen (Efficiency drivePLUS)	%	8 / 16 8 / 16
	5.10	Service brake		generative
E-motor/Electronics	6.1	Drive motor, performance S2 60 min (Efficiency drivePLUS)	kW	2.8 3.2
	6.2	Lift motor, performance with S3	kW	2.2
	6.3	Battery according to DIN 43531/35/36		Jungheinrich Li-ion
	6.4	Battery voltage/nominal capacity	V / Ah	24 / 260
	6.5	Battery weight	kg	100
	6.6.1	Energy consumption according to EN cycle (Efficiency PLUS)	kWh/h	0.42 0.45
	6.6.2	CO2 equivalent as per EN 16796 (Efficiency PLUS)	kg/h	0.2 0.3
	6.7	Throughput (Efficiency PLUS)	t/h	205 210
	6.8	Turnover efficiency according to VDI 2198 (Efficiency PLUS)	t/kWh	139 131
6.8.1	Energy consumption with max. throughput (Efficiency PLUS)	kWh/h	1.48 1.6	

Other	10.7	Sound level as per EN12053, operator's ear	dB (A)	67.1
<p>- This data sheet according to VDI guideline 2198 only states the technical values of the standard truck. Different tyres, other masts, additional equipment etc. may result in different values.</p>				

The values in the table apply to the fixed stand-on platform, integrated M battery compartment, 260-Ah battery, fork length 1,150 mm, raised load section.

Entry height for stand-on platform: 202 / 214 mm (stand-on platform standard / stand-on platform suspension adjustable).

Ground clearance at end of stand-on platform: 117 / 98 mm (stand-on platform standard / stand-on platform compact).

- VDI no. 1.8: lowered load section: x + 66 mm.
- VDI no. 1.9: lowered load section: y + 66 mm.
- VDI no. 4.19: with compact stand-on platform: l1 - 103 mm.
- VDI no. 4.20: with compact stand-on platform: l2 - 103 mm.
- VDI no. 4.34.1: diagonal as per VDI: aisle width + 357 mm. With compact stand-on platform: aisle width - 108 mm.
- VDI no. 4.34.2: diagonal as per VDI: aisle width + 199 mm. With compact stand-on platform: aisle width - 108 mm.
- VDI no. 4.35: lowered load section: Wa + 66 mm. With compact stand-on platform: aisle width - 108 mm.

The German production facilities in
Norderstedt, Moosburg and Landsberg
are certified as well as our Genuine Parts
Center in Kaltenkirchen. ISO 9001
ISO 14001

Jungheinrich fork lift trucks meet
European safety requirements. 

 **JUNGHEINRICH**