

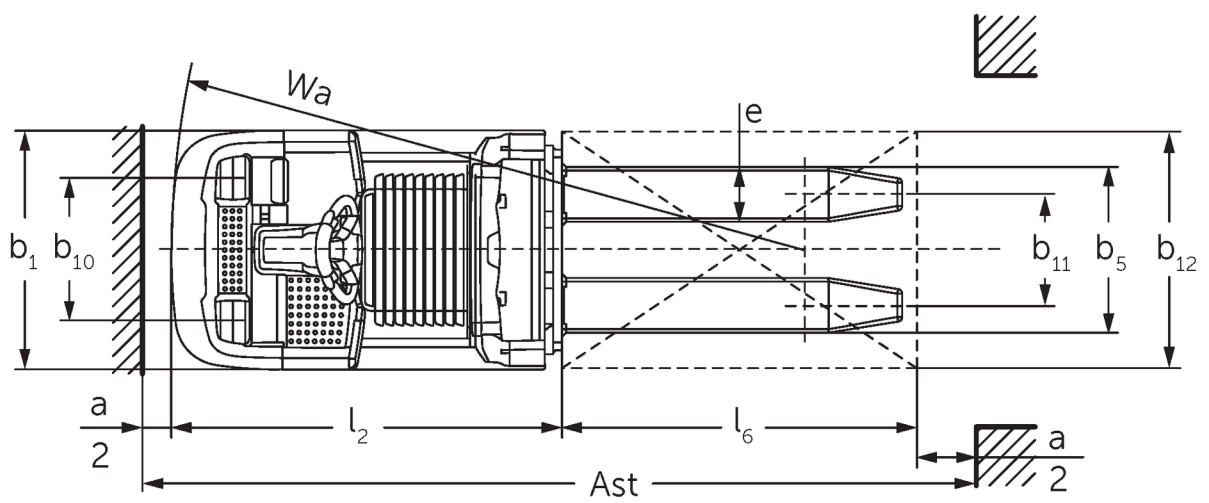

## Low level order pickers **ECE 310**

Lift height: 750 mm / Load capacity: 1000 kg

# ECE 310



# ECE 310

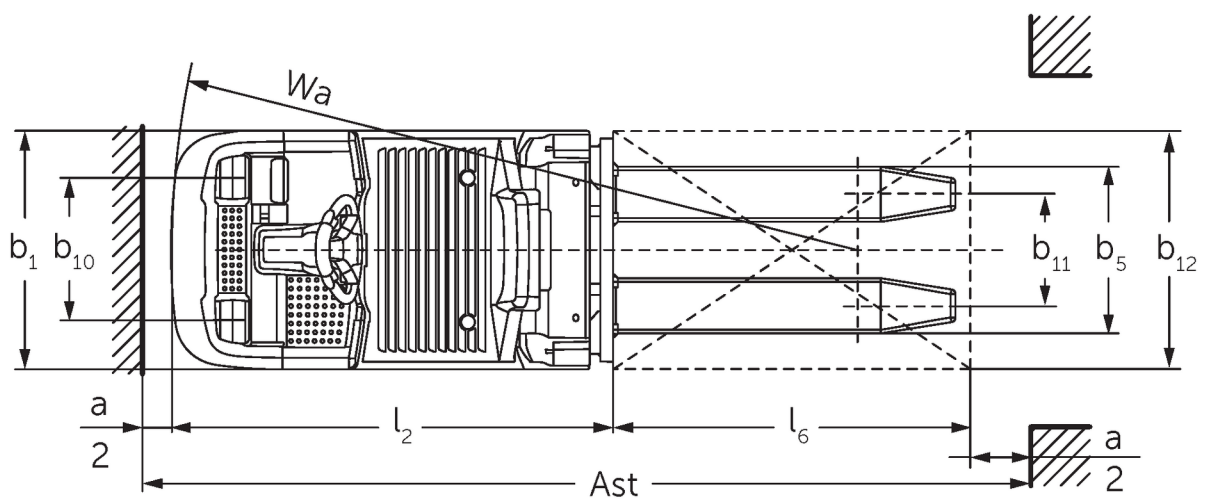

# VDI table

Stand-on: 07/2024

Characteristic	1.1	Manufacturer (abbreviated description)		Jungheinrich	
	1.2	Manufacturer's type designation		ECE 310	ECE 310 HP
	1.3	Drive		Electric	
	1.4	Operation		Order pickers	
	1.5	Load capacity/load	Q kg	1000	
	1.6	Load centre distance	c mm	600	
	1.8	Load distance, centre of drive axle to fork	x mm	821	
	1.9	Wheelbase	y mm	1925	2075
	Weights	2.1.1	Service weight (incl. battery)	kg	1084
2.2		Axle load laden front/rear	kg	839 / 1245	869 / 1405
2.3		Axle load unladen front/rear	kg	772 / 311	862 / 411
Wheels/suspension system	3.1	Tyres		Polyurethane (PU)	
	3.2	Tyre size, front		Ø 230 x 78	
	3.3	Tyre size, rear		Ø 75 x 95	
	3.4	Additional wheels		Ø 180 x 65	
	3.5	Wheels, number front/back (x=driven)		1+1x/2	
	3.6	Tread width, front	b10 mm	481	
	3.7	Tread width, rear	b11 mm	339	
	3.7.1	2. Tread width, rear	mm	379	
Basic dimensions	4.4	Lift (h3)	h3 mm	750	
	4.9	Height of tiller handle in drive position min./max.	h14 mm	1374 / 1418	
	4.15	Height, lowered	h13 mm	90	
	4.19	total length	l1 mm	2471	2621
	4.20	Length including fork shank	l2 mm	1321	1471
	4.21.1	total width	b1 mm	810	
	4.22	Fork dimensions	s/e/l mm	56 x 185 x 1150	
	4.25	Width across forks	b5 mm	560	
	4.32	Ground clearance centre of wheelbase	m2 mm	30	
	4.34.2	Aisle width (pallet 800x1200 length)	Ast mm	2721	2871
	4.35	Turning radius	Wa mm	2142	2292
Performance data	5.1	Travel speed laden/unladen (Efficiency   drivePLUS)	km/h	11.5 / 12.5   11.5 / 14	11 / 12.5   11 / 14
	5.2	Lift speed laden/unladen	m/s	0.17 / 0.33	
	5.3	Lowering speed laden/unladen	m/s	0.19 / 0.19	
	5.8	Max. gradeability laden/unladen (Efficiency   drivePLUS)	%	6 / 15   6 / 15	
	5.10	Service brake		generative	
E-motor/Electronics	6.1	Drive motor, performance S2 60 min (Efficiency   drivePLUS)	kW	2.8   3.2	
	6.2	Lift motor, performance with S3	kW	1.5	
	6.4	Battery voltage/nominal capacity	V / Ah	24 / 465	
	6.5	Battery weight	kg	370	
	6.6.1	Energy consumption according to EN cycle (Efficiency   PLUS)	kWh/h	0.4   0.47	
	6.6.2	CO2 equivalent as per EN 16796 (Efficiency   PLUS)	kg/h	0.2   0.3	
	6.7	Throughput (Efficiency   PLUS)	t/h	65   68	64   67
	6.8.1	Energy consumption with max. throughput (Efficiency   PLUS)	kWh/h	1.27   1.47	1.28   1.47
Other	8.1	Type of drive control		AC	

10.5	Steering version		electric
10.7	Sound level as per EN12053, operator's ear	dB (A)	62
<p>- This data sheet according to VDI guideline 2198 only states the technical values of the standard truck. Different tyres, other masts, additional equipment etc. may result in different values.</p>			

Efficiency: Values of standard package | PLUS: Values of performance package

Values for L battery compartment; fork length 1,150 mm.

- VDI no. 1.9: with XL or XL (ERE) battery compartment:  $y + 118$  mm; with extended stand-on platform:  $y + 50$  mm.
- VDI no. 4.19: with XL or XL (ERE) battery compartment:  $l1 + 118$  mm; with extended stand-on platform:  $l1 + 50$  mm.
- VDI no. 4.20: with XL or XL (ERE) battery compartment:  $l2 + 118$  mm; with extended stand-on platform:  $l2 + 50$  mm.
- VDI no. 4.34.2: with XL or XL (ERE) battery compartment: aisle width + 118 mm; with extended stand-on platform: aisle width + 50 mm; diagonal as per VDI: aisle width + 94 mm.
- VDI no. 4.35: with XL or XL (ERE) battery compartment:  $Wa + 118$  mm; with extended stand-on platform:  $Wa + 50$  mm.
- VDI no. 6.2: with S3 10%.
- VDI no. 6.4: with XL battery compartment: 24 V / 620 Ah.
- VDI no. 6.5: with XL battery compartment: 460 kg.

The German production facilities in  
Norderstedt, Moosburg and Landsberg  
are certified as well as our Genuine Parts  
Center in Kaltenkirchen. ISO 9001  
ISO 14001

Jungheinrich fork lift trucks meet  
European safety requirements. 

**JUNGHEINRICH**