



Electric pedestrian stacker with support arm lift

EJD 118i

Lift height: 1000-1520 mm / Load capacity: 1800 kg

EJD 118i

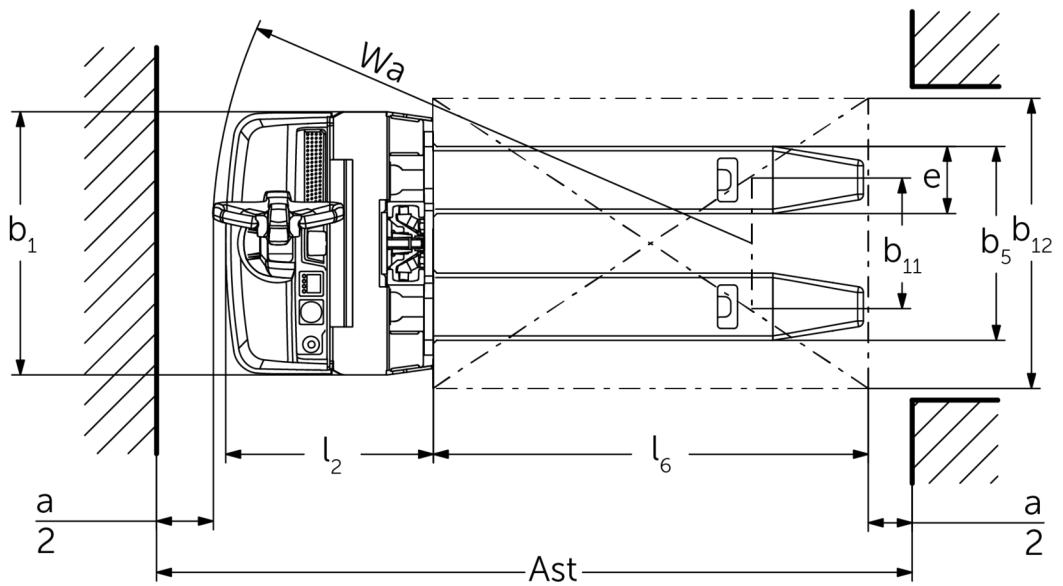
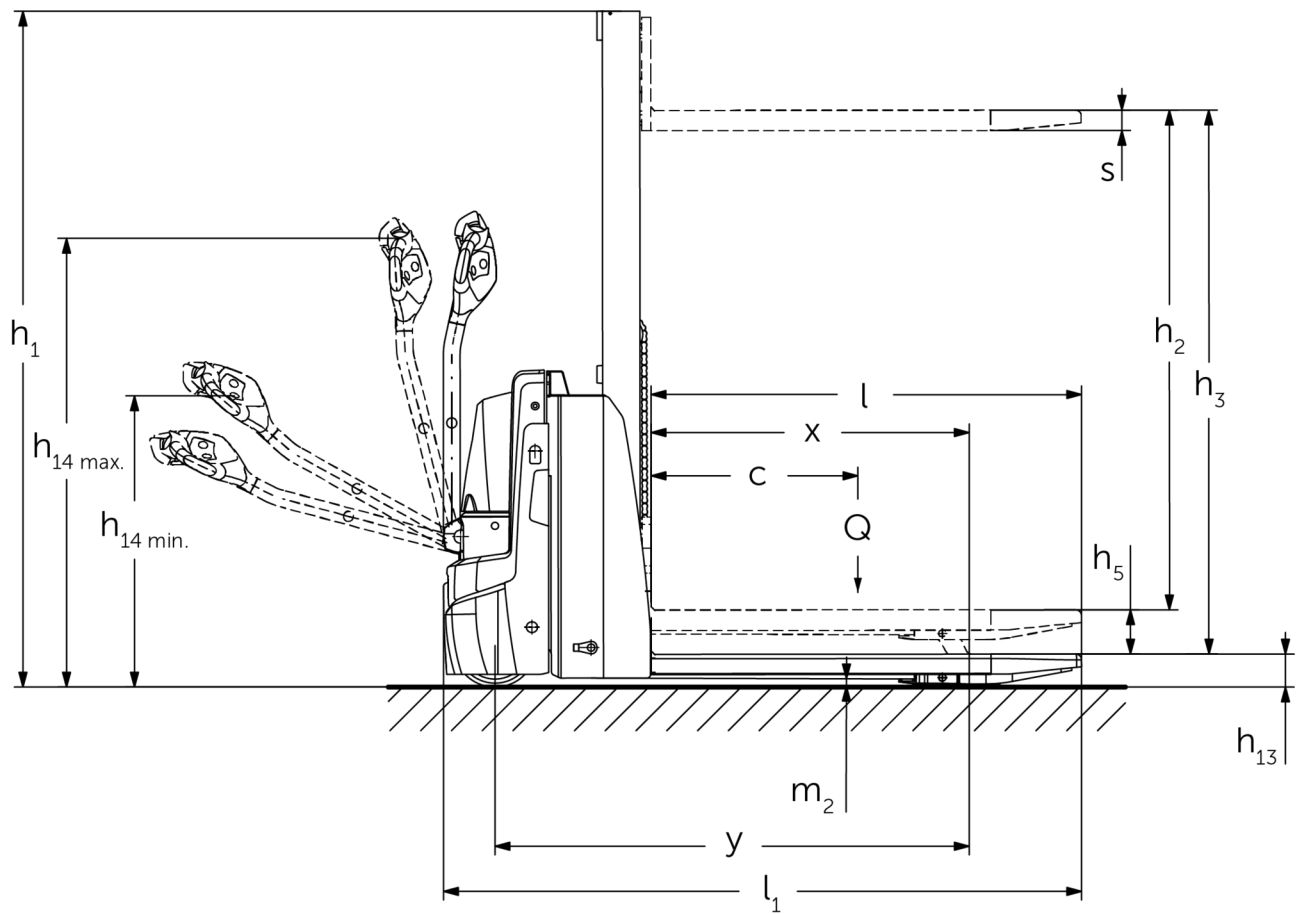

EJD 118i

EJD 118i	Lift (h3)	Retracted mast height (h1)	Free lift (h2)	Extended mast height (h4)
Mono Mast MM	1000 mm	1353 mm	1000 mm	1353 mm
	1520 mm	1863 mm	1520 mm	1863 mm

VDI table

Stand-on: 11/2024

Characteristic	1.1	Manufacturer (abbreviated description)		Jungheinrich
	1.2	Manufacturer's type designation		EJD 118i
	1.3	Drive		Electric
	1.4	Operation		Pedestrian
	1.5	Load capacity/load	Q kg	1800
	1.5.1	Rated capacity/load with mast lift	Q kg	800
	1.5.2	Rated capacity/load with support arm lift	Q kg	1800
	1.6	Load centre distance	c mm	600
	1.8	Load distance, centre of drive axle to fork	x mm	877
1.9	Wheelbase	y mm	1307	
Weights	2.1.1	Service weight (incl. battery)	kg	550
	2.2	Axle load laden front/rear	kg	782 / 1592
	2.3	Axle load unladen front/rear	kg	394 / 156
Wheels/suspension system	3.1	Tyres		Polyurethane (PU)
	3.2	Tyre size, front		Ø 230 x 65
	3.3	Tyre size, rear		Ø 85 x 95 / Ø 85 x 75
	3.4	Additional wheels		Ø 100 x 40
	3.5	Wheels, number front/back (x=driven)		1x +2/2 oder 4
	3.6	Tread width, front	b10 mm	520
	3.7	Tread width, rear	b11 mm	350
Basic dimensions	4.2	Retracted mast height (h1)	h1 mm	1863
	4.3	Free lift (h2)	h2 mm	1520
	4.4	Lift (h3)	h3 mm	1520
	4.5	Extended mast height (h4)	h4 mm	1863
	4.6	Initial lift	h5 mm	120
	4.9	Height of tiller handle in drive position min./max.	h14 mm	820 / 1237
	4.15	Height, lowered	h13 mm	93
	4.19	total length	l1 mm	1759
	4.20	Length including fork shank	l2 mm	572
	4.21.1	total width	b1 mm	726
	4.22	Fork dimensions	s/e/l mm	56 x 185 x 1190
	4.25	Width across forks	b5 mm	535
	4.32	Ground clearance centre of wheelbase	m2 mm	23
	4.34.1	Aisle width (pallet 1000x1200 sideways)	Ast mm	2290
4.34.2	Aisle width (pallet 800x1200 length)	Ast mm	2192	
4.35	Turning radius	Wa mm	1487	
Performance data	5.1	Travel speed laden/unladen	km/h	6 / 6
	5.2	Lift speed laden/unladen	m/s	0.17 / 0.27
	5.3	Lowering speed laden/unladen	m/s	0.31 / 0.19
	5.8	Max. gradeability laden/unladen	%	6 / 15
	5.10	Service brake		generative
E-motor/Electronics	6.1	Drive motor, performance S2 60 min	kW	1.1
	6.2	Lift motor, performance with S3	kW	2.2
	6.3	Battery according to DIN 43531/35/36		DIN 43535 B
	6.4	Battery voltage/nominal capacity	V / Ah	24 / 40
	6.5	Battery weight	kg	15
	6.6	Energy consumption according to VDI cycle	kWh/h	0

	6.6.1	Energy consumption according to EN cycle	kWh/h	0.42
	6.6.2	CO2 equivalent as per EN 16796	kg/h	0.2
	6.7	Throughput	t/h	35
	6.8	Turnover efficiency according to VDI 2198	t/kWh	55
Other	8.1	Type of drive control		AC
	10.7	Schalldruckpegel nach EN12053	dB (A)	66

- This data sheet according to VDI guideline 2198 only states the technical values of the standard truck. Different tyres, other masts, additional equipment etc. may result in different values.

Values for XS battery compartment; MM1520 mast, raised support arm lift.

- VDI no. 1.8: with lowered support arms: $x + 60$ mm.
- VDI no. 1.9: with S battery compartment: $y + 80$ mm; with lowered support arms: $y + 60$ mm.
- VDI no. 4.19: with S battery compartment: $l1 + 80$ mm.
- VDI no. 4.20: with S battery compartment: $l2 + 80$ mm.
- VDI no. 4.34.1: with S battery compartment: aisle width + 80 mm.
- VDI no. 4.31.2: with S battery compartment: aisle width + 80 mm.
- VDI no. 4.35: with S battery compartment: $Wa + 80$ mm.
- VDI no. 6.2: with 5% power-on time.
- VDI no. 10.7: with silentDRIVE options package: 62 dB(A).

The German production facilities in
Norderstedt, Moosburg and Landsberg
are certified as well as our Genuine Parts
Center in Kaltenkirchen. ISO 9001
ISO 14001

Jungheinrich fork lift trucks meet
European safety requirements. 

**JUNGHEINRICH**