



Hand pallet truck

AM 20

Lift height: 85-205 mm / Load capacity: 2000 kg

AM 20

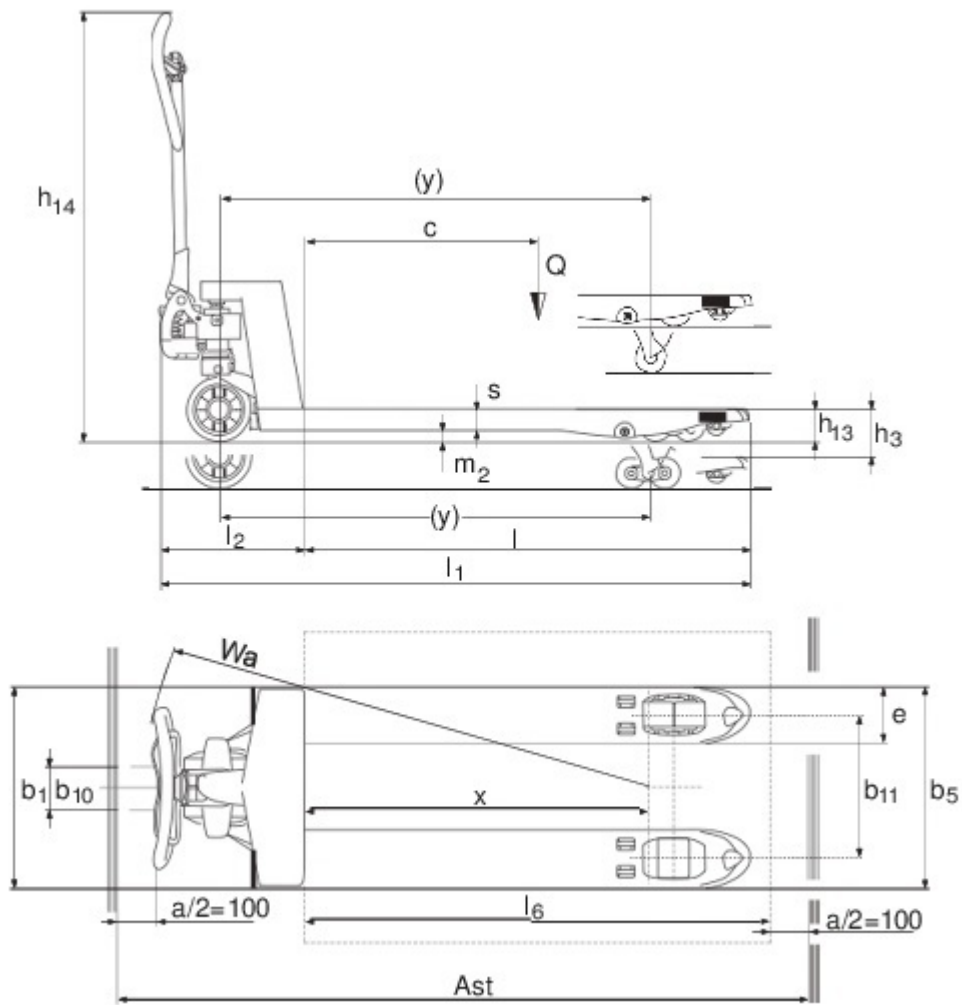

VDI table

Stand-on: 11/2024

Characteristic	1.1	Manufacturer (abbreviated description)		Jungheinrich					
	1.2	Manufacturer's type designation		AM 20					
	1.3	Drive		Manual					
	1.4	Operation		Manual					
	1.5	Load capacity/load	Q kg	2000					
	1.6	Load centre distance	c mm	600					
	1.9	Wheelbase	y mm	1120					
Weights	2.1	tare weight	kg	70	71	70	71	70	71
	2.2	Axle load laden front/rear	kg	549 / 1521					
	2.3	Axle load unladen front/rear	kg	46 / 24					
Wheels/suspension system	3.1	Tyres		C-GV	C-BV	V-GV	V-BV	N-GN	N-BN
	3.2	Tyre size, front		Ø 200 x 50					
	3.3	Tyre size, rear		Ø 82 x 93	Ø 82 x 70	Ø 82 x 93	Ø 82 x 70	Ø 82 x 93	Ø 82 x 70
	3.5	Wheels, number front/back (x=driven)		2/2	2/4	2/2	2/4	2/2	2/4
	3.6	Tread width, front	b10 mm	130					
	3.7	Tread width, rear	b11 mm	380					
	Basic dimensions	4.4	Lift (h3)	h3 mm	115				
4.9		Height of tiller handle in drive position min./max.	h14 mm	355 / 1230					
4.14		Stand height, elevated	h12 mm	200					
4.15		Height, lowered	h13 mm	85					
4.19		total length	l1 mm	1540					
4.20		Length including fork shank	l2 mm	390					
4.21.1		total width	b1 mm	540					
4.22		Fork dimensions	s/ e/l mm	48 x 160 x 1150					
4.25		Width across forks	b5 mm	540					
4.32		Ground clearance centre of wheelbase	m2 mm	37					
4.34.1		Aisle width (pallet 1000x1200 sideways)	Ast mm	1743					
4.34.2		Aisle width (pallet 800x1200 length)	Ast mm	1793					
4.35		Turning radius	Wa mm	1275					
Performance data	5.3	Lowering speed laden/unladen	m/s	0.1 / 0.06					
<p>- This data sheet according to VDI guideline 2198 only states the technical values of the standard truck. Different tyres, other masts, additional equipment etc. may result in different values.</p>									

The German production facilities in
Norderstedt, Moosburg and Landsberg
are certified as well as our Genuine Parts
Center in Kaltenkirchen. ISO 9001
ISO 14001

Jungheinrich fork lift trucks meet
European safety requirements. 

**JUNGHEINRICH**