

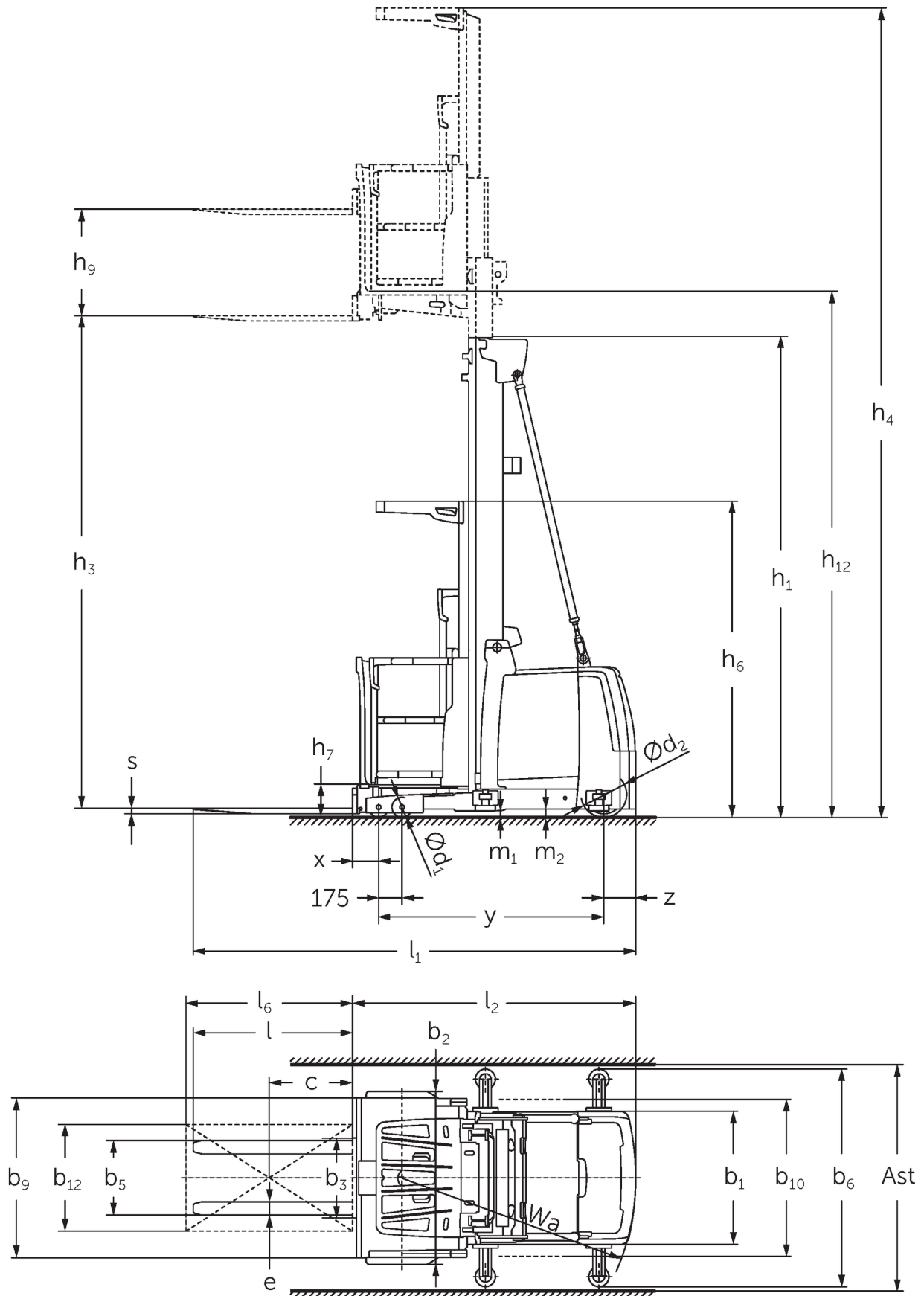

Verticale orderpicker **EKS 412s**

Hefhoogte: 5000-12500 mm / Capaciteit: 1200 kg

EKS 412s



EKS 412s



EKS 412s

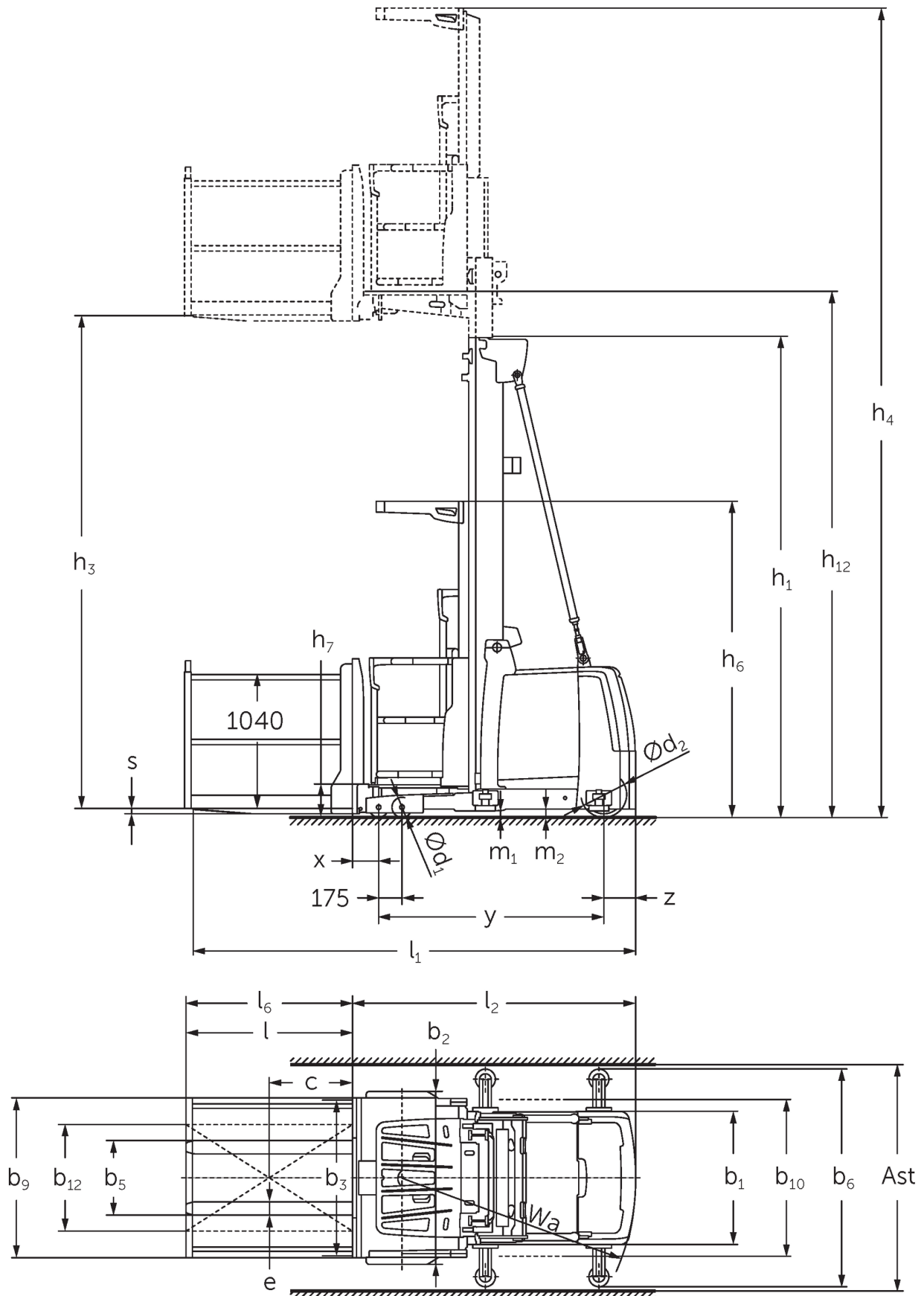

EKS 412s

EKS 412s Z_I, EKS 412s Z_SF, EKS 412s L_I, EKS 412s L_SF, EKS 412s O_I, EKS 412s O_SF	Heffing (h3)	Ingeschoven masthoogte (h1)	Vrije heffing (h2)	Uitgeschoven masthoogte (h4)
Drievoudige mast DT	5500 mm	2610 mm		7870 mm
	6000 mm	2780 mm		8370 mm
	6500 mm	2940 mm		8870 mm
	7000 mm	3110 mm		9370 mm
	7500 mm	3275 mm		9870 mm
	8000 mm	3440 mm		10370 mm
	8500 mm	3610 mm		10870 mm
	9000 mm	3810 mm		11370 mm
	9500 mm	3980 mm		11870 mm
	10500 mm	4410 mm		12870 mm
	11500 mm	4810 mm		13870 mm
	12500 mm	5210 mm		14870 mm
	Drievoudige mast DZ	5500 mm	2610 mm	240 mm
6000 mm		2780 mm	410 mm	8370 mm
6500 mm		2940 mm	570 mm	8870 mm
7000 mm		3110 mm	740 mm	9370 mm
7500 mm		3275 mm	905 mm	9870 mm
8000 mm		3440 mm	1070 mm	10370 mm
8500 mm		3610 mm	1240 mm	10870 mm
9000 mm		3810 mm	1440 mm	11370 mm
9500 mm		3980 mm	1610 mm	11870 mm
10500 mm		4410 mm	2040 mm	12870 mm
11500 mm		4810 mm	2440 mm	13870 mm
12500 mm		5210 mm	2840 mm	14870 mm
Tweevoudige mast ZT		4250 mm	2950 mm	
	5000 mm	3330 mm		7370 mm
	5500 mm	3600 mm		7870 mm
	6000 mm	3850 mm		8370 mm
	6500 mm	4125 mm		8870 mm
	7500 mm	4650 mm		9870 mm
	8500 mm	5150 mm		10870 mm

VDI-tabel

Stand: 11/2024

				EKS 412s Z I	EKS 412s Z SF	EKS 412s L I	EKS 412s L SF	EKS 412s O I	EKS 412s O SF
Kenmerken	1.2	Typeaanduiding fabrikant							
	1.3	Aandrijving		Elektrisch					
	1.4	Bediening		Orderpicker					
	1.5	Capaciteit/last	Q kg	1200					
	1.6	Lastwaartepuntafstand	c mm	400					
	1.8	Lastafstand	x mm	155		145			
	1.9	Wielbasis	y mm	1690					
Gewichten	2.1.1	Eigen gewicht (incl. accu)	kg	3650		3850		3590	
	2.2	Aslast met last voor/achter	kg	3575 / 1160		3825 / 1110		3515 / 1160	
	2.3	Aslast onbelast voor/achter	kg	1840 / 1810		2090 / 1760		1780 / 1810	
Wielen/chassis	3.1	Banden		Polyurethaan (PU)					
	3.2	Bandenmaat, voor		Ø 150 x 100					
	3.3	Bandenmaat, achter		Ø 343 x 110					
	3.5	Wielen, aantal voor/achter (x = aangedreven)		4 / 1 x					
Afmetingen	4.2	Ingeschoven masthoogte (h1)	h1 mm	3330					
	4.4	Heffing (h3)	h3 mm	5000					
	4.5	Uitgeschoven masthoogte (h4)	h4 mm	7370					
	4.7	Hoogte beschermend dak (cabine)	h6 mm	2370					
	4.8.1	Stahoogte	h7 mm	245					
	4.11	Extra heffing	h9 mm	800		-			
	4.14	Stahoogte geheven	h12 mm	5245					
	4.15	Gedaalde hoogte	h13 mm	60					
	4.19	Totale lengte	l1 mm	3285		3330		3275	
	4.20	Lengte inclusief vorkrug	l2 mm	2085		2075			
	4.21.1	Totale breedte	b1 mm	1000					
	4.22	Vorkafmetingen	s/ e/l mm	40 x 100 x 1200		50 x 100 x 1200	50 x 100 x 1250	50 x 100 x 1200	
	4.25	Maat over de vorken	b5 mm	560					
	4.27	Breedte over geleidingswielen	b6 mm	-	1200	-	1200	-	1200
4.31	Bodemvrijheid met last onder hefmast	m1 mm	50						
4.35	Draaicirkel	Wa mm	1930						
Prestaties	5.1	Rijsnelheid met last/onbelast	km/u	12 / 12					
	5.2	Hefsnelheid met last/onbelast	m/s	0,5 / 0,5					
	5.3	Daalsnelheid met last/onbelast	m/s	0,5 / 0,4					
	5.10	Rem		regeneratief					
	5.11	Parkeerrem		elektrische veeraccumulator					
E-motor/ elektronica	6.1	Rijmotor, vermogen S2 60 min	kW	6,5					
	6.2	Hefmotor, vermogen bij S3	kW	12					
	6.4	Accuspanning/nominaal vermogen	V / Ah	48 / 620					
	6.5	Accugewicht	kg	935					
Overig	8.1	Type rijregeling		AC synchrone reluctantie					
	10.5	Uitvoering besturing		elektrisch					
	10.7	Schalldrukpegel nach EN12053	dB (A)	60					

- Dit typeblad volgens VDI-richtlijn 2198 noemt alleen de technische waarden van de standaardmachine. Afwijkende banden, andere hefmasten, extra systemen etc. kunnen resulteren in andere waarden.

De Duitse fabrieken in Norderstedt,
Moosburg en Landsberg zijn
gecertificeerd, evenals ons
onderdelenmagazijn in Kaltenkirchen. ISO 9001
ISO 14001

Jungheinrich intern transport materieel
voldoet aan de Europese
veiligheidsvoorschriften. 

**JUNGHEINRICH**