

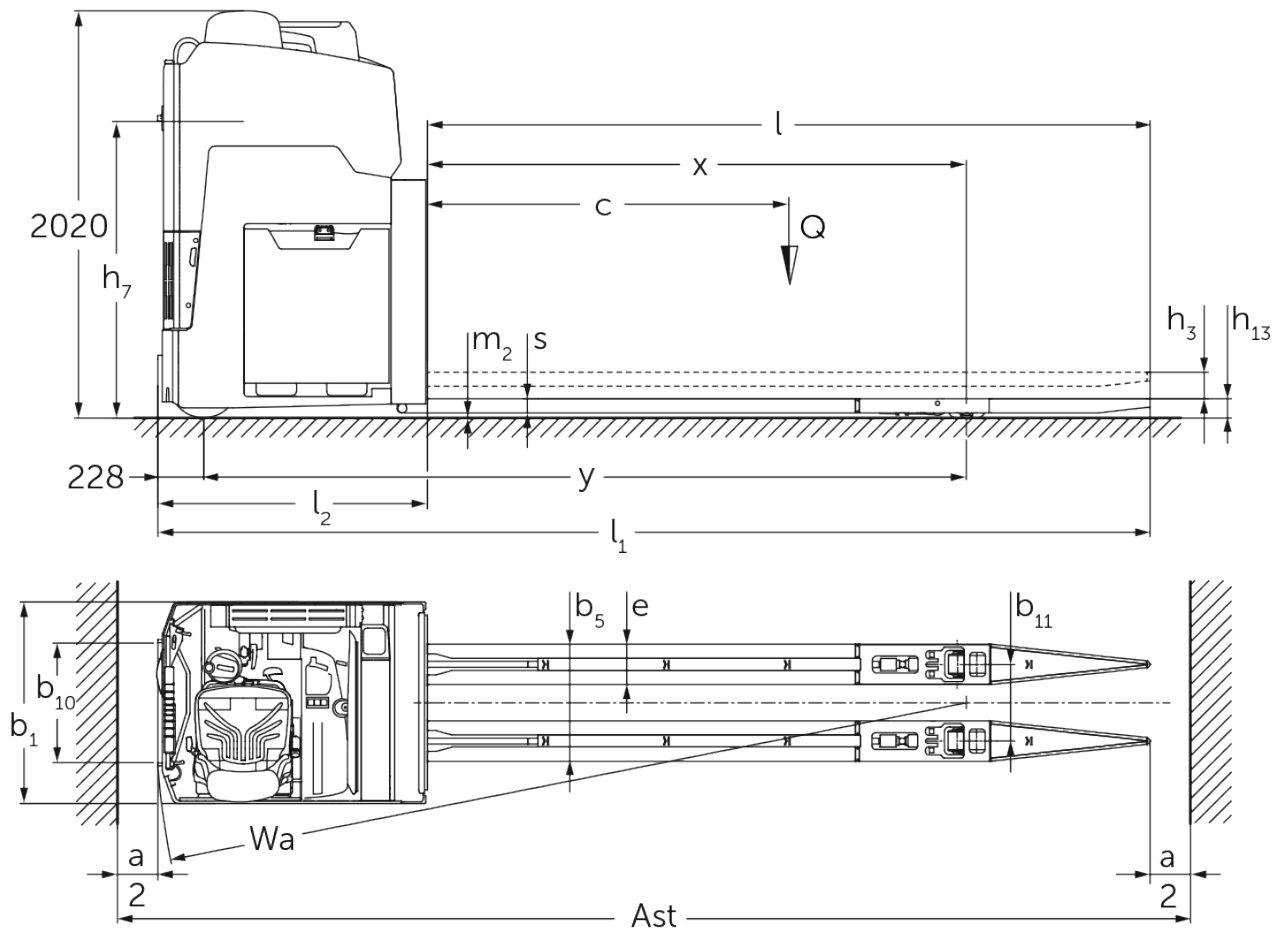

Electric sideways-seated pallet truck **ESE 533**

Lift height: 115 mm / Load capacity: 3300 kg

ESE 533



VDI table

Stand-on: 11/2024

Characteristic	1.1	Manufacturer (abbreviated description)			Jungheinrich
	1.2	Manufacturer's type designation			ESE 533
	1.3	Drive			Electric
	1.4	Operation			Seat
	1.5	Load capacity/load	Q	kg	3300
	1.6	Load centre distance	c	mm	1800
	1.8	Load distance, centre of drive axle to fork	x	mm	2673
	1.9	Wheelbase	y	mm	3785
	Weights	2.1.1	Service weight (incl. battery)		kg
2.2		Axle load laden front/rear		kg	3555 / 3240
2.3		Axle load unladen front/rear		kg	2745 / 745
Wheels/suspension system	3.1	Tyres			Vulkollan ®
	3.2	Tyre size, front			Ø 343 x 140
	3.3	Tyre size, rear			Ø 90 x 100
	3.5	Wheels, number front/back (x=driven)			2x / 4
	3.6	Tread width, front	b10	mm	592
	3.7	Tread width, rear	b11	mm	380
	Basic dimensions	4.4	Lift (h3)	h3	mm
4.8		Seat height/stand height	h7	mm	1470
4.15		Height, lowered	h13	mm	95
4.19		total length	l1	mm	4895
4.20		Length including fork shank	l2	mm	1340
4.21.1		total width	b1	mm	1000
4.22		Fork dimensions	s/e/l	mm	70 x 200 x 3600
4.25		Width across forks	b5	mm	580
4.32		Ground clearance centre of wheelbase	m2	mm	20
4.34.2		Aisle width (pallet 800x1200 length)	Ast	mm	5340
4.35		Turning radius	Wa	mm	4025
Performance data	5.1	Travel speed laden/unladen		km/h	20 / 20
	5.2	Lift speed laden/unladen		m/s	0.06 / 0.06
	5.3	Lowering speed laden/unladen		m/s	0.05 / 0.05
	5.7	Gradeability laden/unladen		%	5 / 10
	5.10	Service brake			electric
E-motor/Electronics	6.1	Drive motor, performance S2 60 min		kW	8.5
	6.1.1	2. Drive motor, performance S2 60 min		kW	8.5
	6.2	Lift motor, performance with S3		kW	2
	6.3	Battery according to DIN 43531/35/36			no
	6.4	Battery voltage/nominal capacity		V / Ah	48 / 1000
	6.5	Battery weight		kg	1450
	6.6	Energy consumption according to VDI cycle		kWh/h	0
	6.6.1	Energy consumption according to EN cycle		kWh/h	0.92
6.6.2	CO2 equivalent as per EN 16796		kg/h	0.5	
Other	8.1	Type of drive control			Mosfet/AC

- This data sheet according to VDI guideline 2198 only states the technical values of the standard truck. Different tyres, other masts, additional equipment etc. may result in different values.

The German production facilities in
Norderstedt, Moosburg and Landsberg
are certified as well as our Genuine Parts
Center in Kaltenkirchen. ISO 9001
ISO 14001

Jungheinrich fork lift trucks meet
European safety requirements. 

**JUNGHEINRICH**