



Hand pallet truck galvanised **AM G20**

Lift height: 122 mm / Load capacity: 2000 kg

JUNGHEINRICH

AM G20

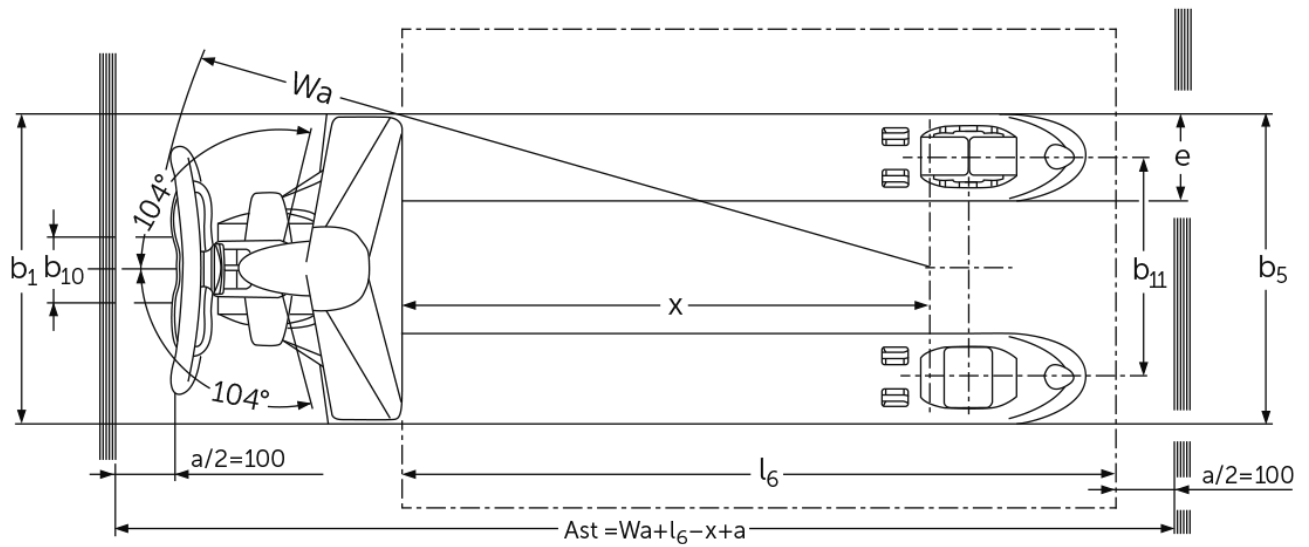
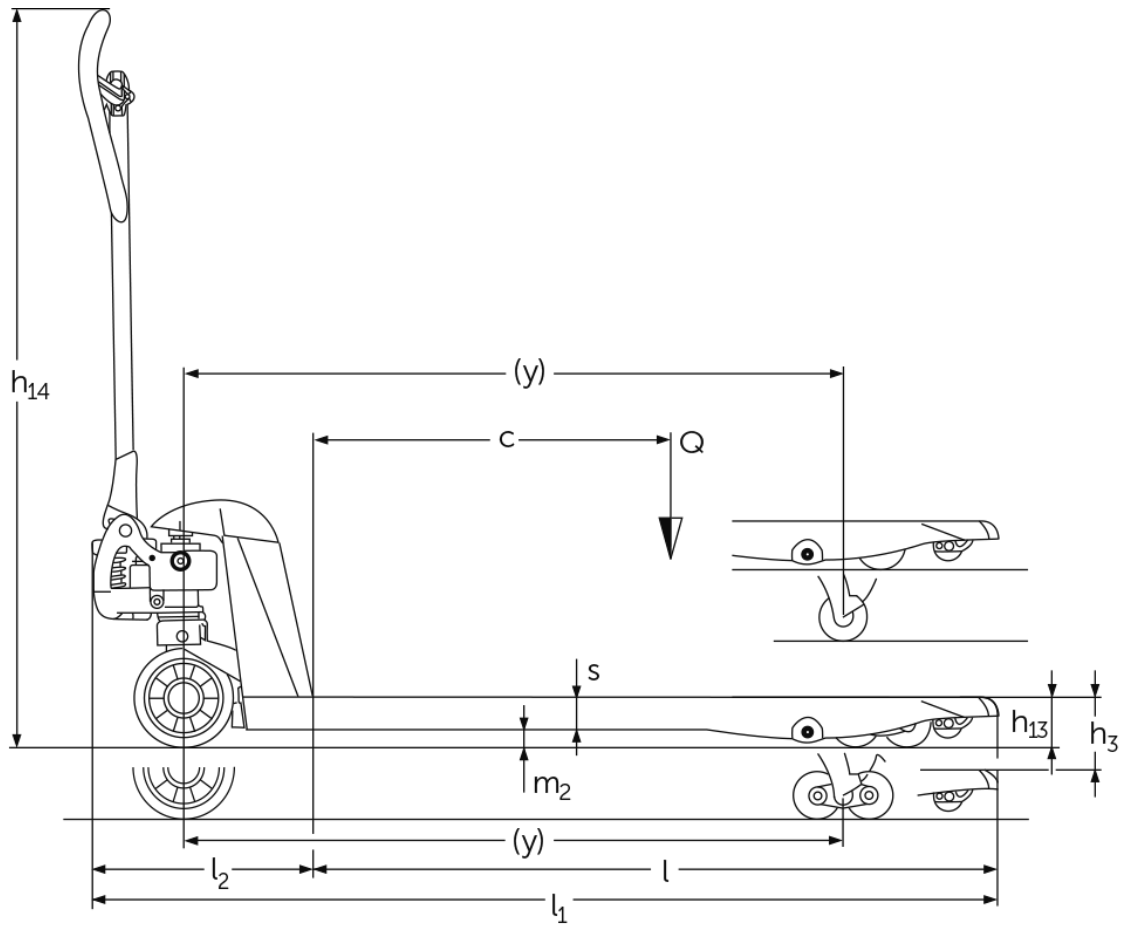

VDI table

Stand-on: 11/2024

Characteristic	1.1	Manufacturer (abbreviated description)		Jungheinrich				
	1.2	Manufacturer's type designation		AM G20				
	1.3	Drive		Manual				
	1.4	Operation		Manual				
	1.5	Load capacity/load	Q kg	2000				
	1.6	Load centre distance	c mm	600		500	400	
	1.9	Wheelbase	y mm	1110	-	1110	910	755
Weights	2.1	tare weight	kg	61	60		54	51
	2.3	Axle load unladen front/rear	kg	38 / 20	- / -	38 / 20	- / -	
Wheels/suspension system	3.1	Tyres		N-GN	N-BN	V-BV	N-GN	
	3.2	Tyre size, front		Ø 170x50	-	Ø 170 x 50	Ø 170x50	
	3.3	Tyre size, rear		Ø 82x96	-	Ø 82 x 62	Ø 82x96	
	3.5	Wheels, number front/back (x=driven)		2/2	-	2/2		
	3.6	Tread width, front	b10 mm	109	-	109		
	3.7	Tread width, rear	b11 mm	370	-	370		
Basic dimensions	4.4	Lift (h3)	h3 mm	122				
	4.9	Height of tiller handle in drive position min./max.	h14 mm	1234	-	1234		
	4.14	Stand height, elevated	h12 mm	205				
	4.15	Height, lowered	h13 mm	83				
	4.19	total length	l1 mm	1520	1523		1320	1165
	4.20	Length including fork shank	l2 mm	373				
	4.21.1	total width	b1 mm	520				
	4.22	Fork dimensions	s/ e/l mm	53 x 150 x 1150			53 x 150 x 950	53 x 150 x 795
	4.25	Width across forks	b5 mm	520				
	4.32	Ground clearance centre of wheelbase	m2 mm	30				
	4.34.1	Aisle width (pallet 1000x1200 sideways)	Ast mm	1734	-	1734	1584	
	4.34.2	Aisle width (pallet 800x1200 length)	Ast mm	1784	-	1784		
	4.35	Turning radius	Wa mm	1274	-	1274	1074	919
Performance data	5.3	Lowering speed laden/unladen	m/s	0.09 / 0.02	- / -	0.09 / 0.02		
<p>- This data sheet according to VDI guideline 2198 only states the technical values of the standard truck. Different tyres, other masts, additional equipment etc. may result in different values.</p>								

The German production facilities in
Norderstedt, Moosburg and Landsberg
are certified as well as our Genuine Parts
Center in Kaltenkirchen. ISO 9001
ISO 14001

Jungheinrich fork lift trucks meet
European safety requirements. 

**JUNGHEINRICH**