



Electric stand-on/sideways-seated pallet truck

ESE 430

Lift height: 115 mm / Load capacity: 3000 kg

ESE 430

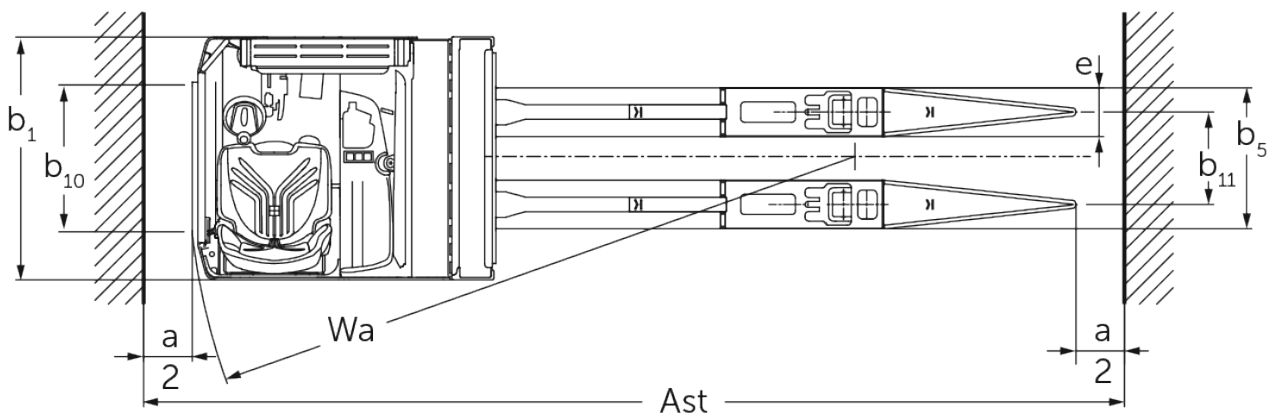
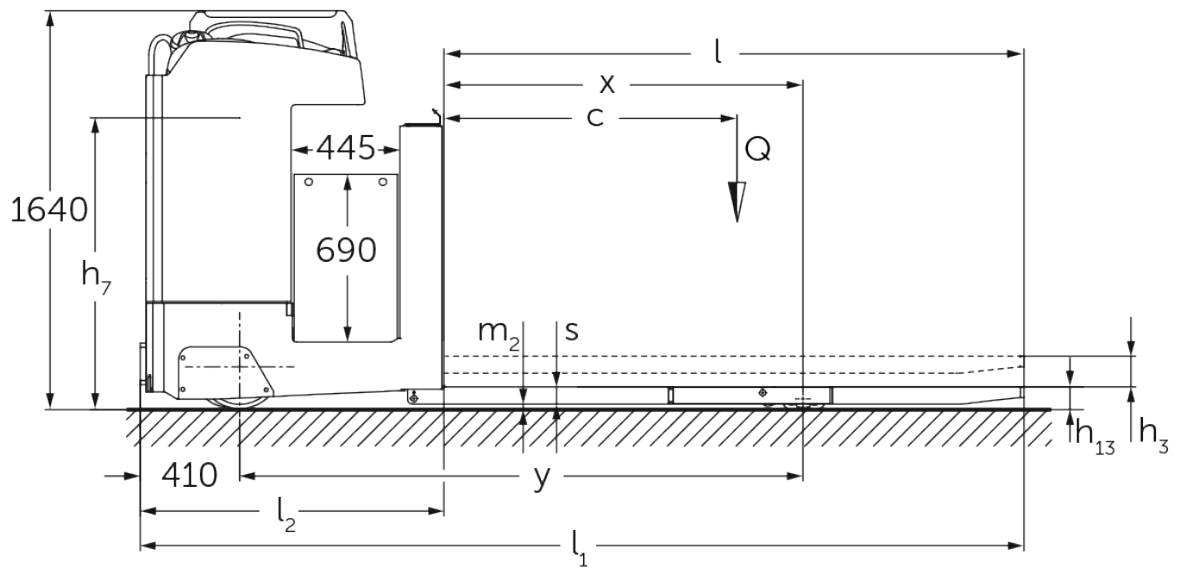

VDI table

Stand-on: 12/2024

Characteristic	1.1	Manufacturer (abbreviated description)			Jungheinrich
	1.2	Manufacturer's type designation			ESE 4
	1.3	Drive			Electric
	1.4	Operation			Seat
	1.5	Load capacity/load	Q	kg	3000
	1.6	Load centre distance	c	mm	1200
	1.8	Load distance, centre of drive axle to fork	x	mm	1480
	1.9	Wheelbase	y	mm	2320
	Weights	2.1.1	Service weight (incl. battery)		kg
2.2		Axle load laden front/rear		kg	2190 / 3280
2.3		Axle load unladen front/rear		kg	1975 / 500
Wheels/suspension system	3.1	Tyres			Vulkollan ®
	3.2	Tyre size, front			Ø 343 x 114
	3.3	Tyre size, rear			Ø 90 x 100
	3.4	Additional wheels			Ø 285 x 100
	3.5	Wheels, number front/back (x=driven)			2 - 1x / 4
	3.6	Tread width, front	b10	mm	604
	3.7	Tread width, rear	b11	mm	380
Basic dimensions	4.4	Lift (h3)	h3	mm	115
	4.8	Seat height/stand height	h7	mm	1200
	4.15	Height, lowered	h13	mm	90
	4.19	total length	l1	mm	3650
	4.20	Length including fork shank	l2	mm	1250
	4.21.1	total width	b1	mm	1000
	4.22	Fork dimensions	s/e/l	mm	70 x 200 x 2400
	4.25	Width across forks	b5	mm	580
	4.32	Ground clearance centre of wheelbase	m2	mm	20
	4.34.2	Aisle width (pallet 800x1200 length)	Ast	mm	4050
	4.35	Turning radius	Wa	mm	2750
Performance data	5.1	Travel speed laden/unladen		km/h	14 / 14
	5.2	Lift speed laden/unladen		m/s	0.06 / 0.06
	5.3	Lowering speed laden/unladen		m/s	0.05 / 0.05
	5.7	Gradeability laden/unladen		%	6 / 15
	5.10	Service brake			electric
E - motor/Electronics	6.1	Drive motor, performance S2 60 min		kW	8.5
	6.2	Lift motor, performance with S3		kW	2
	6.3	Battery according to DIN 43531/35/36			A
	6.4	Battery voltage/nominal capacity		V / Ah	48 / 620
	6.5	Battery weight		kg	945
	6.6.1	Energy consumption according to EN cycle		kWh/h	0.56
	6.6.2	CO2 equivalent as per EN 16796		kg/h	0.3
Other	8.1	Type of drive control			Mosfet/AC

- This data sheet according to VDI guideline 2198 only states the technical values of the standard truck. Different tyres, other masts, additional equipment etc. may result in different values.

The German production facilities in
Norderstedt, Moosburg and Landsberg
are certified as well as our Genuine Parts
Center in Kaltenkirchen. ISO 9001
ISO 14001

Jungheinrich fork lift trucks meet
European safety requirements. 

 **JUNGHEINRICH**