



Hand pallet truck with scales **AMW 22 / 22p**

Lift height: 122 mm / Load capacity: 2200 kg

JUNGHEINRICH

AMW 22 / 22p

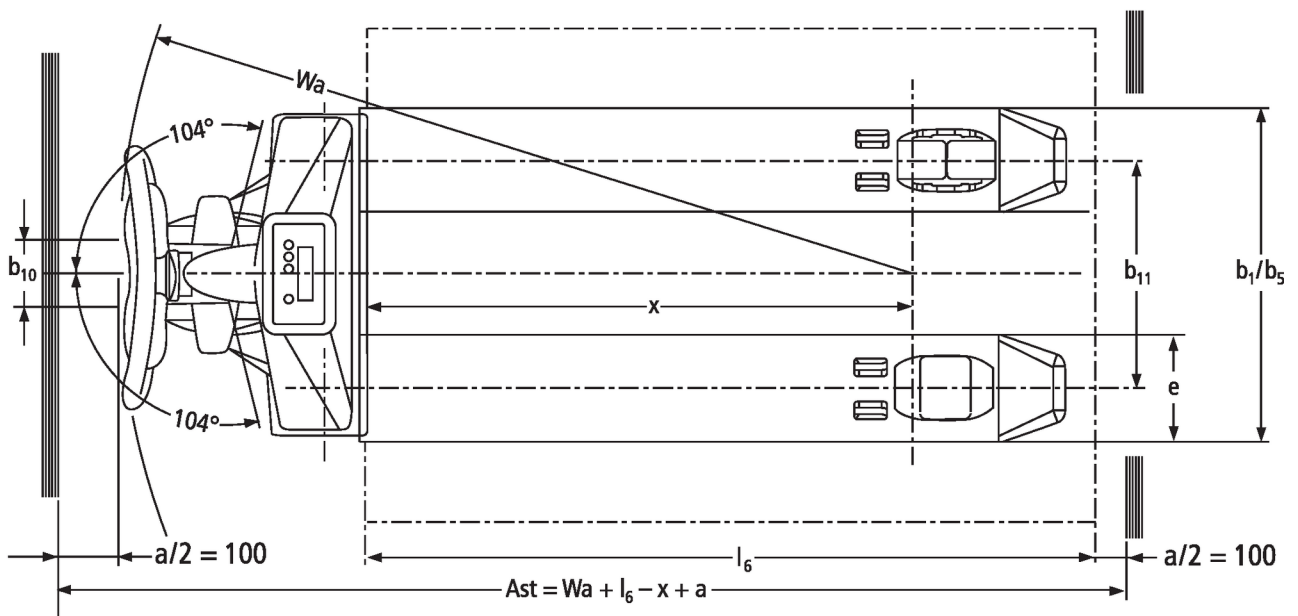

VDI table

Stand-on: 12/2024

Characteristic	1.1	Manufacturer (abbreviated description)		Jungheinrich							
	1.2	Manufacturer's type designation		AMW 22 / p							
	1.3	Drive		Manual							
	1.4	Operation		Manual							
	1.5	Load capacity/load	Q kg	2200							
	1.6	Load centre distance	c mm	600							
	1.9	Wheelbase	y mm	1110							
Weights	2.1	tare weight	kg	99		102					
	2.2	Axle load laden front/rear	kg	578 / 1721							
	2.3	Axle load unladen front/rear	kg	61 / 38							
Wheels/suspension system	3.1	Tyres		C-BV	V-GV	C-GV	V-BV	C-GV	C-BV	V-GV	V-BV
	3.2	Tyre size, front		Ø 170x50	Ø 170 x 50	Ø 170x50	Ø 170 x 50	Ø 170x50	Ø 170 x 50	Ø 170 x 50	Ø 170x50
	3.3	Tyre size, rear		Ø 82x96	Ø 82 x 96	Ø 82x96	Ø 82 x 96	Ø 82x96	Ø 82 x 96	Ø 82 x 96	Ø 82x96
	3.5	Wheels, number front/back (x=driven)		2/2							
	3.6	Tread width, front	b10 mm	109							
	3.7	Tread width, rear	b11 mm	370							
	Basic dimensions	4.4	Lift (h3)	h3 mm	122						
4.9		Height of tiller handle in drive position min./max.	h14 mm	1234							
4.15		Height, lowered	h13 mm	86							
4.19		total length	l1 mm	1546							
4.20		Length including fork shank	l2 mm	396							
4.21.1		total width	b1 mm	540							
4.22		Fork dimensions	s/ e/l mm	62 x 170 x 1150							
4.25		Width across forks	b5 mm	540							
4.32		Ground clearance centre of wheelbase	m2 mm	24							
4.34.1		Aisle width (pallet 1000x1200 sideways)	Ast mm	1763							
4.34.2		Aisle width (pallet 800x1200 length)	Ast mm	1813							
4.35	Turning radius	Wa mm	1303								
Performance data	5.3	Lowering speed laden/unladen	m/s	0.09 / 0.02							
E-motor/ Electronics	6.4	Battery voltage/nominal capacity	V	1.5	12 / 1.2	1.5	12 / 1.2				

- This data sheet according to VDI guideline 2198 only states the technical values of the standard truck. Different tyres, other masts, additional equipment etc. may result in different values.

The German production facilities in
Norderstedt, Moosburg and Landsberg
are certified as well as our Genuine Parts
Center in Kaltenkirchen. ISO 9001
ISO 14001

Jungheinrich fork lift trucks meet
European safety requirements. 

**JUNGHEINRICH**