



# Electric stand-on and sideways-seated stacker

## ESD 220

Lift height: 1660 mm / Load capacity: 2000 kg

# ESD 220

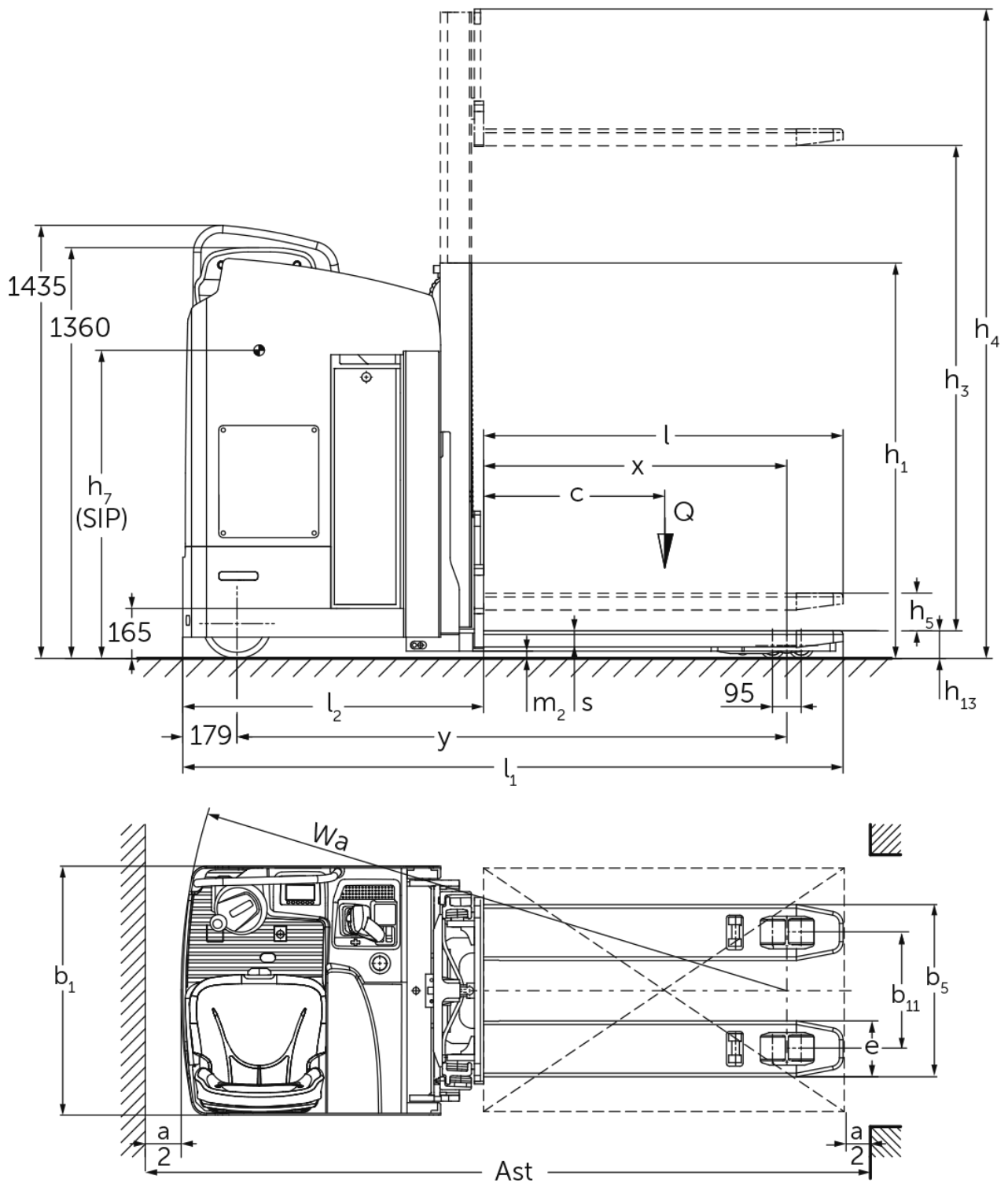

# ESD 220

ESD 220	Lift (h3)	Retracted mast height (h1)	Free lift (h2)	Extended mast height (h4)
Duplex mast ZT	1660 mm	1310 mm	100 mm	2150 mm

# VDI table

Stand-on: 01/2025

Characteristic	1.1	Manufacturer (abbreviated description)		Jungheinrich	
	1.2	Manufacturer's type designation		<b>ESD 220</b>	
	1.3	Drive		Electric	
	1.4	Operation		Seat	
	1.5	Load capacity/load	Q	kg	2000
	1.5.1	Rated capacity/load with mast lift	Q	kg	1000
	1.5.2	Rated capacity/load with support arm lift	Q	kg	2000
	1.6	Load centre distance	c	mm	600
	1.8	Load distance, centre of drive axle to fork	x	mm	1004
1.9	Wheelbase	y	mm	1820	
Weights	2.1.1	Service weight (incl. battery)		kg	1350
	2.2	Axle load laden front/rear		kg	1340 / 2010
	2.3	Axle load unladen front/rear		kg	982 / 368
Wheels/suspension system	3.1	Tyres			Polyurethane (PU)
	3.2	Tyre size, front			Ø 230 x 77
	3.3	Tyre size, rear			Ø 85 x 85
	3.4	Additional wheels			Ø 140 x 54
	3.5	Wheels, number front/back (x=driven)			2 + 1x / 4
	3.6	Tread width, front	b10	mm	544
	3.7	Tread width, rear	b11	mm	380
Basic dimensions	4.2	Retracted mast height (h1)	h1	mm	1310
	4.3	Free lift (h2)	h2	mm	100
	4.4	Lift (h3)	h3	mm	1660
	4.5	Extended mast height (h4)	h4	mm	2150
	4.6	Initial lift	h5	mm	110
	4.8	Seat height/stand height	h7	mm	1020
	4.15	Height, lowered	h13	mm	90
	4.19	total length	l1	mm	2185
	4.20	Length including fork shank	l2	mm	995
	4.21.1	total width	b1	mm	820
	4.22	Fork dimensions	s/e/l	mm	65 x 185 x 1190
	4.25	Width across forks	b5	mm	570
	4.32	Ground clearance centre of wheelbase	m2	mm	25
	4.34.2	Aisle width (pallet 800x1200 length)	Ast	mm	2399
4.35	Turning radius	Wa	mm	2003	
Performance data	5.1	Travel speed laden/unladen		km/h	9.1 / 9.1
	5.2	Lift speed laden/unladen		m/s	0.2 / 0.39
	5.3	Lowering speed laden/unladen		m/s	0.47 / 0.47
	5.8	Max. gradeability laden/unladen		%	8 / 14
	5.10	Service brake			generative
E-motor/Electronics	6.1	Drive motor, performance S2 60 min		kW	2.8
	6.2	Lift motor, performance with S3		kW	3
	6.3	Battery according to DIN 43531/35/36			no
	6.4	Battery voltage/nominal capacity		V / Ah	24 / 465
	6.5	Battery weight		kg	380
	6.6	Energy consumption according to VDI cycle		kWh/h	0
	6.6.1	Energy consumption according to EN cycle		kWh/h	0.61

	6.6.2	CO2 equivalent as per EN 16796	kg/h	0.3
Other	8.1	Type of drive control		AC
- This data sheet according to VDI guideline 2198 only states the technical values of the standard truck. Different tyres, other masts, additional equipment etc. may result in different values.				

The values in the table apply for mast ZT 1660, lowered support arm lift.

VDI no. 1.8: raised support arm lift: x - 78 mm.

VDI no. 1.9: raised support arm lift: y - 78 mm.

VDI no. 4.35: raised support arm lift: Wa - 78 mm.

The German production facilities in  
Norderstedt, Moosburg and Landsberg  
are certified as well as our Genuine Parts  
Center in Kaltenkirchen. ISO 9001  
ISO 14001

Jungheinrich fork lift trucks meet  
European safety requirements. 

 **JUNGHEINRICH**