



Hand pallet truck

AM 120 / 120p

Lift height: 120 mm / Load capacity: 2000 kg

AM 120 / 120p

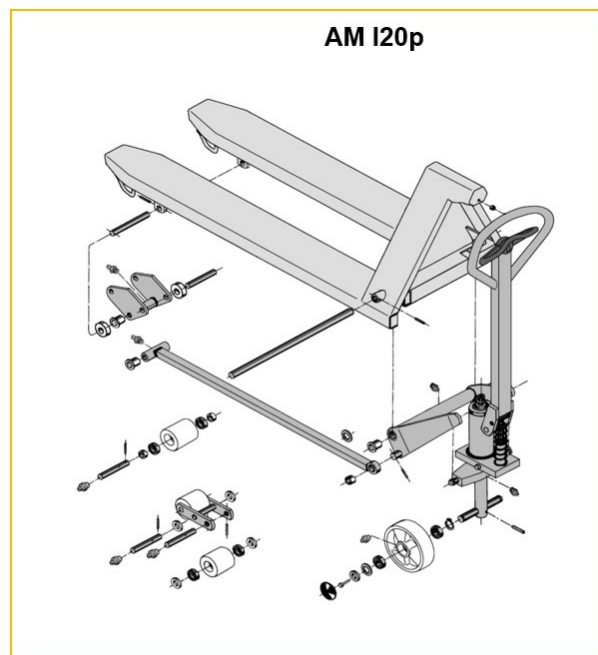
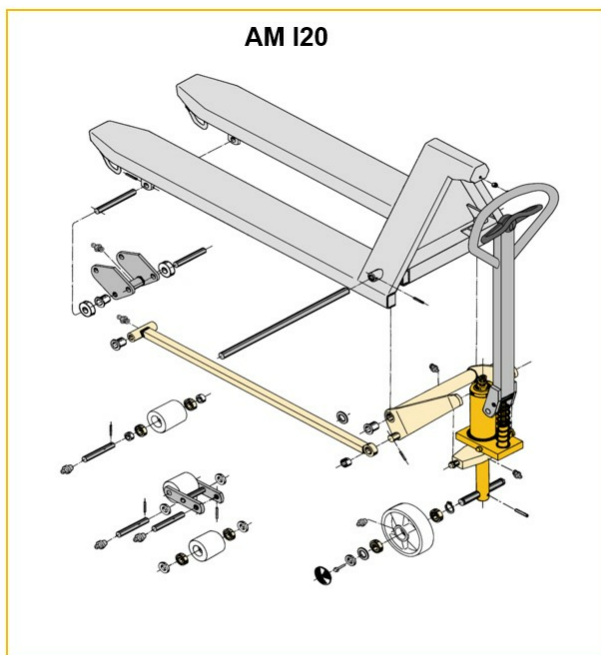

Inox AISI 316 (V4A)

Feuerverzinkt

Inox AISI 303/304 (V2A)

Verzinkt und gelb chromatiert

AM l20 / l20p



AM l20 / l20p



VDI table

Stand-on: 01/2025

Characteristic	1.1	Manufacturer (abbreviated description)		Jungheinrich											
	1.2	Manufacturer's type designation		AM I20 / I20p											
	1.3	Drive		Manual											
	1.4	Operation		Manual											
	1.5	Load capacity/load	Q kg	2000											
	1.6	Load centre distance	c mm	610	570				485						
	1.9	Wheelbase	y mm	1245				1165				995			
Weights	2.1	tare weight	kg	81			78			75			72		
	2.1.1	Service weight (incl. battery)	kg	81			78			-			72		
Wheels/suspension system	3.1	Tyres		V-BV	N-BN	V-GV	N-GN	V-BV	N-BN	C-GV	N-GN	V-BV	N-BN		
	3.2	Tyre size, front		Ø 200x50											
	3.3	Tyre size, rear		Ø 80x70	Ø 80x65	Ø 80x90	Ø 80x70	Ø 80x65	Ø 80x90	Ø 80x70	Ø 80x65				
	3.5	Wheels, number front/back (x=driven)		2/2											
	3.6	Tread width, front	b10 mm	120											
	3.7	Tread width, rear	b11 mm	520											
	Basic dimensions	4.4	Lift (h3)	h3 mm	120										
4.9		Height of tiller handle in drive position min./max.	h14 mm	1170											
4.14		Stand height, elevated	h12 mm	205											
4.15		Height, lowered	h13 mm	85											
4.19		total length	l1 mm	1555			1475			1305					
4.21.1		total width	b1 mm	680											
4.22		Fork dimensions	s/e/l mm	51 x 160 x 1220			51 x 160 x 1140			51 x 160 x 970					
4.25		Width across forks	b5 mm	680											
4.32		Ground clearance centre of wheelbase	m2 mm	34											
4.34.1		Aisle width (pallet 1000x1200 sideways)	Ast mm	1610											
4.34.2		Aisle width (pallet 800x1200 length)	Ast mm	1830			1810								
4.35		Turning radius	Wa mm	1410			1330			1160					
Performance data	5.3	Lowering speed laden/unladen	m/s	0.1 / 0.05											
- This data sheet according to VDI guideline 2198 only states the technical values of the standard truck. Different tyres, other masts, additional equipment etc. may result in different values.															

Characteristic	1.1	Manufacturer (abbreviated description)		Jungheinrich											
	1.2	Manufacturer's type designation		AM I20 / I20p											
	1.3	Drive		Manual											
	1.4	Operation		Manual											
	1.5	Load capacity/load	Q kg	2000											
	1.6	Load centre distance	c mm	485	405				610						
	1.9	Wheelbase	y mm	995				835				1245			

Weights	2.1	tare weight	kg	69				65	75	72			
	2.1.1	Service weight (incl. battery)	kg	69	66	-			75	72			
Wheels/suspension system	3.1	Tyres		V-GV	N-GN	V-BV	N-BN	V-GV	N-GN	V-BV	N-BN	V-GV	N-GN
	3.2	Tyre size, front		Ø 200x50									
	3.3	Tyre size, rear		Ø 80x90	Ø 80x70	Ø 80x65	Ø 80x90	Ø 80x70	Ø 80x65	Ø 80x90			
	3.5	Wheels, number front/back (x=driven)		2/2									
	3.6	Tread width, front	b10 mm	120									
	3.7	Tread width, rear	b11 mm	520					360				
	Basic dimensions	4.4	Lift (h3)	h3 mm	120								
4.9		Height of tiller handle in drive position min./max.	h14 mm	1170									
4.14		Stand height, elevated	h12 mm	205									
4.15		Height, lowered	h13 mm	85									
4.19		total length	l1 mm	1305	1145				1555				
4.21.1		total width	b1 mm	680				520					
4.22		Fork dimensions	s/ e/l mm	51 x 160 x 970	51 x 160 x 810				51 x 160 x 1220				
4.25		Width across forks	b5 mm	680				520					
4.32		Ground clearance centre of wheelbase	m2 mm	34									
4.34.1		Aisle width (pallet 1000x1200 sideways)	Ast mm	1610									
4.34.2		Aisle width (pallet 800x1200 length)	Ast mm	1810					1830				
4.35	Turning radius	Wa mm	1160	1000				1410					
Performance data	5.3	Lowering speed laden/unladen	m/s	0.1 / 0.05									
- This data sheet according to VDI guideline 2198 only states the technical values of the standard truck. Different tyres, other masts, additional equipment etc. may result in different values.													

Characteristic	1.1	Manufacturer (abbreviated description)		Jungheinrich									
	1.2	Manufacturer's type designation		AM I20 / I20p									
	1.3	Drive		Manual									
	1.4	Operation		Manual									
	1.5	Load capacity/load	Q kg	2000									
	1.6	Load centre distance	c mm	570				485				405	
	1.9	Wheelbase	y mm	1165				995				835	
Weights	2.1	tare weight	kg	72	69			66	63				
	2.1.1	Service weight (incl. battery)	kg	-				66	63	-			
	2.2	Axle load laden front/rear	-	- / -		636 / 1432		- / -					
	2.3	Axle load unladen front/rear	-	- / -		21 / 47		- / -					
Wheels/suspension system	3.1	Tyres		V-BV	N-BN	V-GV	N-GN	V-BV	N-BN	V-GV	N-GN	V-BV	N-BN
	3.2	Tyre size, front		Ø 200x50									
	3.3	Tyre size, rear		Ø 80x70	Ø 80x65	Ø 80x90		Ø 80x70	Ø 80x65	Ø 80x90	Ø 80x70	Ø 80x65	
	3.5	Wheels, number front/back (x=driven)		2/2									
	3.6	Tread width, front	b10 mm	120									

	3.7	Tread width, rear	b11 mm	360			335
Basic dimensions	4.4	Lift (h3)	h3 mm	120			
	4.9	Height of tiller handle in drive position min./max.	h14 mm	1170	1220 / 1170	1170	
	4.14	Stand height, elevated	h12 mm	205			
	4.15	Height, lowered	h13 mm	85			
	4.19	total length	l1 mm	1475	1305		1145
	4.20	Length including fork shank	l2 mm	-	340	-	
	4.21.1	total width	b1 mm	520			
	4.22	Fork dimensions	s/ e/l mm	51 x 160 x 1140	51 x 160 x 970		51 x 160 x 810
	4.25	Width across forks	b5 mm	520			
	4.32	Ground clearance centre of wheelbase	m2 mm	34			
	4.34.1	Aisle width (pallet 1000x1200 sideways)	Ast mm	1610			
	4.34.2	Aisle width (pallet 800x1200 length)	Ast mm	1810			
	4.35	Turning radius	Wa mm	1330	1160		1000
	Performance data	5.3	Lowering speed laden/unladen	m/s	0.1 / 0.05		
- This data sheet according to VDI guideline 2198 only states the technical values of the standard truck. Different tyres, other masts, additional equipment etc. may result in different values.							

Characteristic	1.1	Manufacturer (abbreviated description)		Jungheinrich								
	1.2	Manufacturer's type designation		AM 120 / I20p								
	1.3	Drive		Manual								
	1.4	Operation		Manual								
	1.5	Load capacity/load	Q kg	2000								
	1.6	Load centre distance	c mm	405				485				
	1.9	Wheelbase	y mm	835				995				
Weights	2.1	tare weight	kg	59		63			66			
	2.1.1	Service weight (incl. battery)	kg	-	59	63			66			
Wheels/suspension system	3.1	Tyres		V-GV	N-GN	V-GV	N-BN	V-BV	N-GN	V-GV	N-BN	V-BV
	3.2	Tyre size, front		Ø 200x50								
	3.3	Tyre size, rear		Ø 80x90		Ø 80x65	Ø 80x70	Ø 80x90	Ø 80x65	Ø 80x70		
	3.5	Wheels, number front/back (x=driven)		2/2								
	3.6	Tread width, front	b10 mm	120								
	3.7	Tread width, rear	b11 mm	335	360							
	Basic dimensions	4.4	Lift (h3)	h3 mm	120							
4.9		Height of tiller handle in drive position min./max.	h14 mm	1170								
4.14		Stand height, elevated	h12 mm	205	200							
4.15		Height, lowered	h13 mm	85								
4.19		total length	l1 mm	1145				1305				

	4.21.1	total width	b1 mm	520		
	4.22	Fork dimensions	s/ e/l mm	51 x 160 x 810		51 x 160 x 970
	4.25	Width across forks	b5 mm	520		
	4.32	Ground clearance centre of wheelbase	m2 mm	34	38	
	4.34.1	Aisle width (pallet 1000x1200 sideways)	Ast mm	1610		
	4.34.2	Aisle width (pallet 800x1200 length)	Ast mm	1810		
	4.35	Turning radius	Wa mm	1000		1160
Performance data	5.3	Lowering speed laden/unladen	m/s	0.1 / 0.05		

- This data sheet according to VDI guideline 2198 only states the technical values of the standard truck. Different tyres, other masts, additional equipment etc. may result in different values.

Characteristic	1.1	Manufacturer (abbreviated description)	Jungheinrich												
	1.2	Manufacturer's type designation	AM I20 / I20p												
	1.3	Drive	Manual												
	1.4	Operation	Manual												
	1.5	Load capacity/load	Q kg	2000											
	1.6	Load centre distance	c mm	570			610			405					
	1.9	Wheelbase	y mm	1165			1245			835					
Weights	2.1	tare weight	kg	69	72			75			65				
	2.1.1	Service weight (incl. battery)	kg	69	72			75			65				
	2.2	Axle load laden front/rear	kg	636 / 1432	- / -										
	2.3	Axle load unladen front/rear	kg	21 / 47	- / -										
Wheels/suspension system	3.1	Tyres	N-GN V-GV N-BN V-BV N-GN V-GV N-BN V-BV N-GN V-GV												
	3.2	Tyre size, front	Ø 200x50												
	3.3	Tyre size, rear	Ø 80x90	Ø 80x65	Ø 80x70	Ø 80x90	Ø 80x65	Ø 80x90							
	3.5	Wheels, number front/back (x=driven)	2/2												
	3.6	Tread width, front	b10 mm	120											
	3.7	Tread width, rear	b11 mm	360								520			
	Basic dimensions	4.4	Lift (h3)	h3 mm	120										
4.9		Height of tiller handle in drive position min./max.	h14 mm	1170											
4.14		Stand height, elevated	h12 mm	200											
4.15		Height, lowered	h13 mm	85											
4.19		total length	l1 mm	1475			1555			1145					
4.20		Length including fork shank	l2 mm	340	-										
4.21.1		total width	b1 mm	520								680			
4.22		Fork dimensions	s/ e/l mm	51 x 160 x 1140				51 x 160 x 1220				51 x 160 x 810			
4.25		Width across forks	b5 mm	520											
4.32		Ground clearance centre of wheelbase	m2 mm	38											
4.34.1		Aisle width (pallet 1000x1200 sideways)	Ast mm	1610											
4.34.2		Aisle width (pallet 800x1200 length)	Ast mm	1810			1830			1810					
4.35		Turning radius	Wa mm	1330			1410			1000					

Performance data	5.3	Lowering speed laden/unladen	m/s	0.1 / 0.05
------------------	-----	------------------------------	-----	------------

- This data sheet according to VDI guideline 2198 only states the technical values of the standard truck. Different tyres, other masts, additional equipment etc. may result in different values.

Characteristic	1.1	Manufacturer (abbreviated description)		Jungheinrich									
	1.2	Manufacturer's type designation		AM I20 / I20p									
	1.3	Drive		Manual									
	1.4	Operation		Manual									
	1.5	Load capacity/load	Q kg	2000									
	1.6	Load centre distance	c mm	405	485				570				
	1.9	Wheelbase	y mm	835	995				1165				
Weights	2.1	tare weight	kg	69			72		75		78		
	2.1.1	Service weight (incl. battery)	kg	69			72		75		78		
Wheels/suspension system	3.1	Tyres		V-BV	N-BN	N-GN	V-GV	N-BN	V-BV	N-GN	V-GV	N-BN	V-BV
	3.2	Tyre size, front		Ø 200x50									
	3.3	Tyre size, rear		Ø 80x70	Ø 80x65	Ø 80x90	Ø 80x65	Ø 80x70	Ø 80x90	Ø 80x65	Ø 80x70		
	3.5	Wheels, number front/back (x=driven)		2/2									
	3.6	Tread width, front	b10 mm	120									
	3.7	Tread width, rear	b11 mm	520									
	Basic dimensions	4.4	Lift (h3)	h3 mm	120								
4.9		Height of tiller handle in drive position min./max.	h14 mm	1170									
4.14		Stand height, elevated	h12 mm	200									
4.15		Height, lowered	h13 mm	85									
4.19		total length	l1 mm	1145			1305			1475			
4.21.1		total width	b1 mm	680									
4.22		Fork dimensions	s/e/l mm	51 x 160 x 810			51 x 160 x 970			51 x 160 x 1140			
4.25		Width across forks	b5 mm	680									
4.32		Ground clearance centre of wheelbase	m2 mm	38									
4.34.1		Aisle width (pallet 1000x1200 sideways)	Ast mm	1610									
4.34.2		Aisle width (pallet 800x1200 length)	Ast mm	1810									
4.35	Turning radius	Wa mm	1000			1160			1330				
Performance data	5.3	Lowering speed laden/unladen	m/s	0.1 / 0.05									

- This data sheet according to VDI guideline 2198 only states the technical values of the standard truck. Different tyres, other masts, additional equipment etc. may result in different values.

Characteristic	1.1	Manufacturer (abbreviated description)		Jungheinrich			
	1.2	Manufacturer's type designation		AM I20 / I20p			
	1.3	Drive		Manual			
	1.4	Operation		Manual			
	1.5	Load capacity/load	Q kg	2000			
	1.6	Load centre distance	c mm	610			
	1.9	Wheelbase	y mm	1245			
Weights	2.1	tare weight	kg	78			81
	2.1.1	Service weight (incl. battery)	kg	78			81
Wheels/suspension system	3.1	Tyres		N-GN	V-GV	V-BV	N-BN
	3.2	Tyre size, front		Ø 200x50			
	3.3	Tyre size, rear		Ø 80x90			Ø 80x65
	3.5	Wheels, number front/back (x=driven)		2/2			
	3.6	Tread width, front	b10 mm	120			
	3.7	Tread width, rear	b11 mm	520			
	Basic dimensions	4.4	Lift (h3)	h3 mm	120		
4.9		Height of tiller handle in drive position min./max.	h14 mm	1170			
4.14		Stand height, elevated	h12 mm	200			
4.15		Height, lowered	h13 mm	85			
4.19		total length	l1 mm	1555			
4.21.1		total width	b1 mm	680			
4.22		Fork dimensions	s/ e/l mm	51 x 160 x 1220			
4.25		Width across forks	b5 mm	680			
4.32		Ground clearance centre of wheelbase	m2 mm	38			
4.34.1		Aisle width (pallet 1000x1200 sideways)	Ast mm	1610			
4.34.2		Aisle width (pallet 800x1200 length)	Ast mm	1830			
4.35	Turning radius	Wa mm	1410				
Performance data	5.3	Lowering speed laden/unladen	m/s	0.1 / 0.05			

- This data sheet according to VDI guideline 2198 only states the technical values of the standard truck. Different tyres, other masts, additional equipment etc. may result in different values.

The German production facilities in
Norderstedt, Moosburg and Landsberg
are certified as well as our Genuine Parts
Center in Kaltenkirchen. ISO 9001
ISO 14001

Jungheinrich fork lift trucks meet
European safety requirements. 

 **JUNGHEINRICH**