

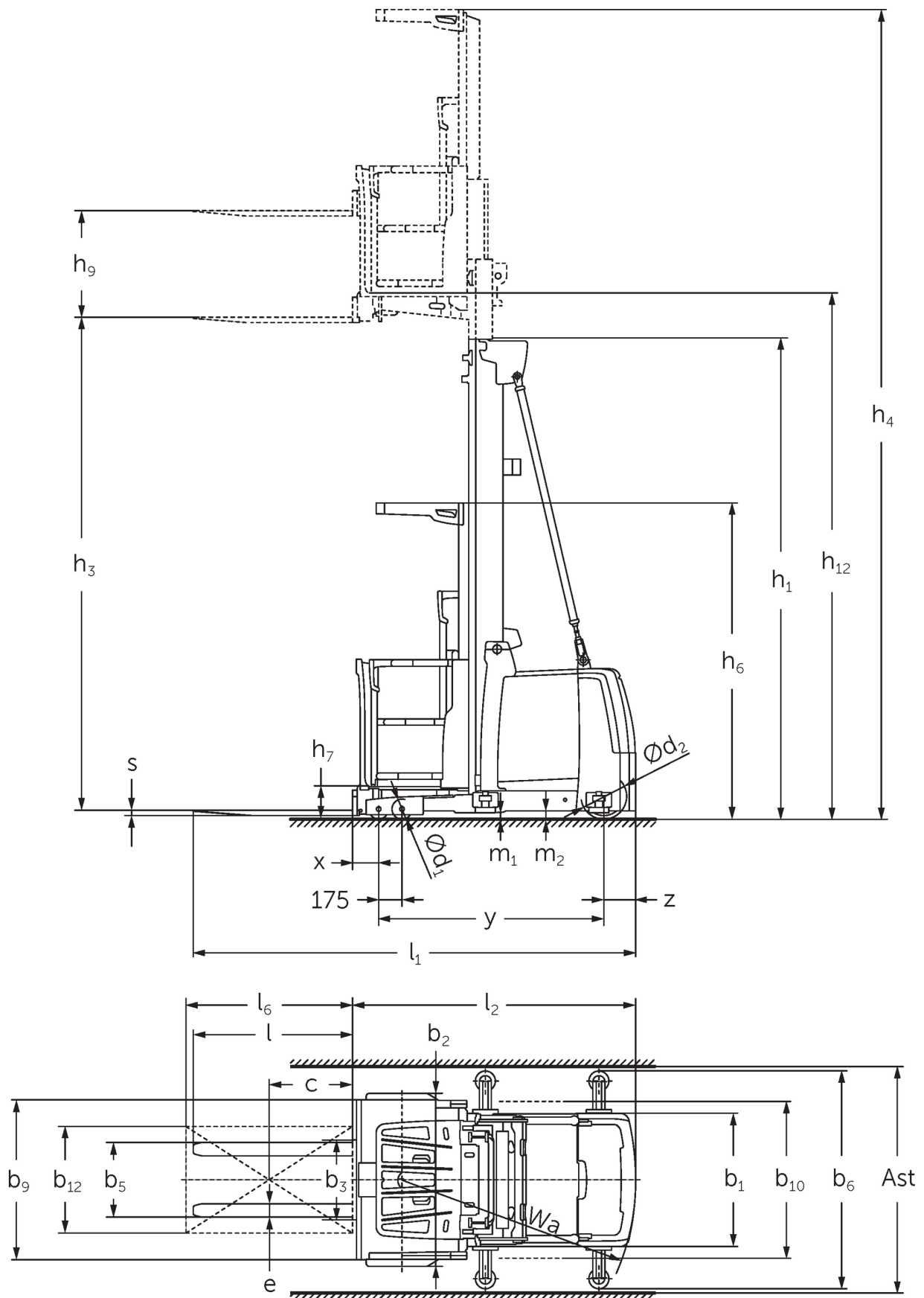

Medium/high level order picker **EKS 310s**

Lift height: 4250-7000 mm / Load capacity: 1000 kg

EKS 310s



EKS 310s



EKS 310s



EKS 310s

EKS 310s Z_I, EKS 310s Z_SF, EKS 310s L_I, EKS 310s L_SF, EKS 310s O_I, EKS 310s O_SF	Lift (h3)	Retracted mast height (h1)	Free lift (h2)	Extended mast height (h4)
Duplex mast ZT	2800 mm	2325 mm		5170 mm
	3500 mm	2550 mm		5870 mm
	4250 mm	2950 mm		6620 mm
	5000 mm	3330 mm		7370 mm
	5500 mm	3600 mm		7870 mm
	6000 mm	3850 mm		8370 mm
Triplex mast DT	4750 mm	2370 mm		7120 mm
	5500 mm	2610 mm		7870 mm
	6000 mm	2780 mm		8370 mm
	6500 mm	2940 mm		8870 mm
	7000 mm	3110 mm		9370 mm
Triplex mast DZ	4750 mm	2370 mm		7120 mm
	5500 mm	2610 mm	240 mm	7870 mm
	6000 mm	2780 mm	410 mm	8370 mm
	6500 mm	2940 mm	570 mm	8870 mm
	7000 mm	3110 mm	740 mm	9370 mm

VDI table

Stand-on: 01/2025

Characteristic	1.1	Manufacturer (abbreviated description)		Jungheinrich		
	1.2	Manufacturer's type designation		EKS 310s		
	1.3	Drive		Electric		
	1.4	Operation		Order pickers		
	1.5	Load capacity/load	Q kg	1000		
	1.6	Load centre distance	c mm	400		
	1.8	Load distance, centre of drive axle to fork	x mm	155		
	1.9	Wheelbase	y mm	1520		
	Weights	2.1.1	Service weight (incl. battery)	kg	2600	
2.2		Axle load laden front/rear	kg	2740 / 860	2770 / 830	2695 / 855
2.3		Axle load unladen front/rear	kg	1240 / 1360	1270 / 1330	1195 / 1355
Wheels/ suspension system	3.1	Tyres		Polyurethane (PU)		
	3.2	Tyre size, front		Ø 150 x 100		
	3.3	Tyre size, rear		Ø 250 x 80		
	3.5	Wheels, number front/back (x=driven)		4 / 1 x		
Basic dimensions	4.2	Retracted mast height (h1)	h1 mm	2950		
	4.4	Lift (h3)	h3 mm	4250		
	4.5	Extended mast height (h4)	h4 mm	6620		
	4.7	Height of overhead guard (cab)	h6 mm	2370		
	4.8.1	Stand height	h7 mm	245		
	4.14	Stand height, elevated	h12 mm	4495		
	4.15	Height, lowered	h13 mm	60		
	4.19	total length	l1 mm	3095	3140	3085
	4.20	Length including fork shank	l2 mm	1895	1885	
	4.21.1	total width	b1 mm	900		
	4.22	Fork dimensions	s/ e/l mm	40 x 100 x 1200	50 x 100 x 1250	50 x 100 x 1200
	4.25	Width across forks	b5 mm	560		
	4.31	Ground clearance laden under mast	m1 mm	50		
4.35	Turning radius	Wa mm	1643			
Performance data	5.1	Travel speed laden/unladen	km/h	11 / 11		
	5.2	Lift speed laden/unladen	m/s	0.5 / 0.5		
	5.3	Lowering speed laden/unladen	m/s	0.5 / 0.4		
	5.10	Service brake		regenerative		
	5.11	Parking brake		Electric sprung-loaded		
E-motor/ Electronics	6.1	Drive motor, performance S2 60 min	kW	3		
	6.2	Lift motor, performance with S3	kW	12		
	6.4	Battery voltage/nominal capacity	V / Ah	48 / 465		
	6.5	Battery weight	kg	740		
Other	8.1	Type of drive control		AC synchronous reluctance		
	10.5	Steering version		electric		
	10.7	Sound level as per EN12053, operator's ear	dB (A)	59		

- This data sheet according to VDI guideline 2198 only states the technical values of the standard truck. Different tyres, other masts, additional equipment etc. may result in different values.

The German production facilities in
Norderstedt, Moosburg and Landsberg
are certified as well as our Genuine Parts
Center in Kaltenkirchen. ISO 9001
ISO 14001

Jungheinrich fork lift trucks meet
European safety requirements. 

 **JUNGHEINRICH**