

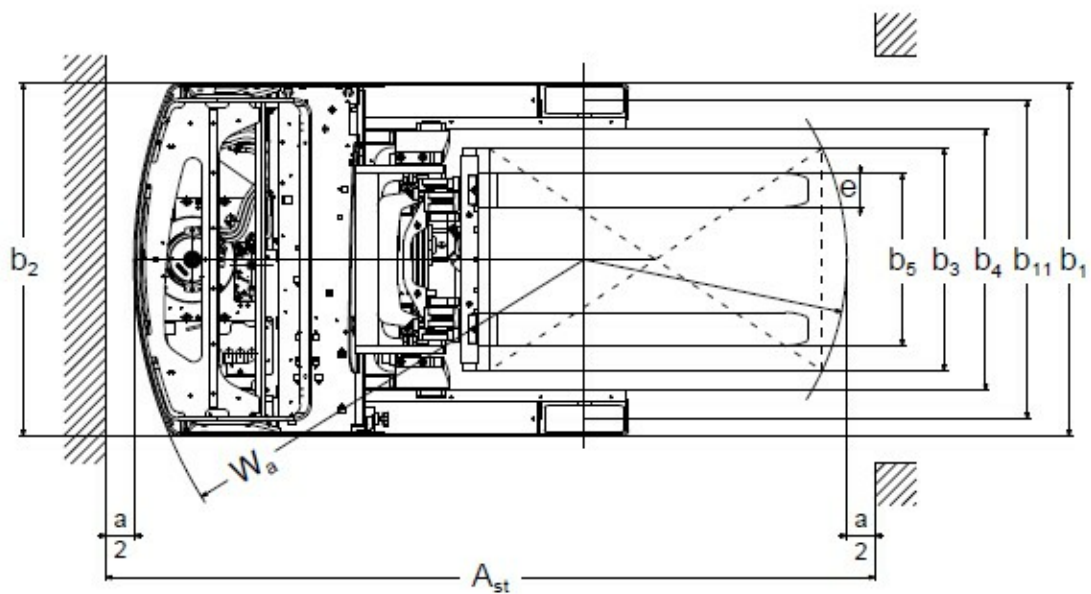

Electric reach truck **ETV MB 214/216**

Lift height: 5000-10700 mm / Load capacity: 1400-1600 kg

ETV MB 214/216

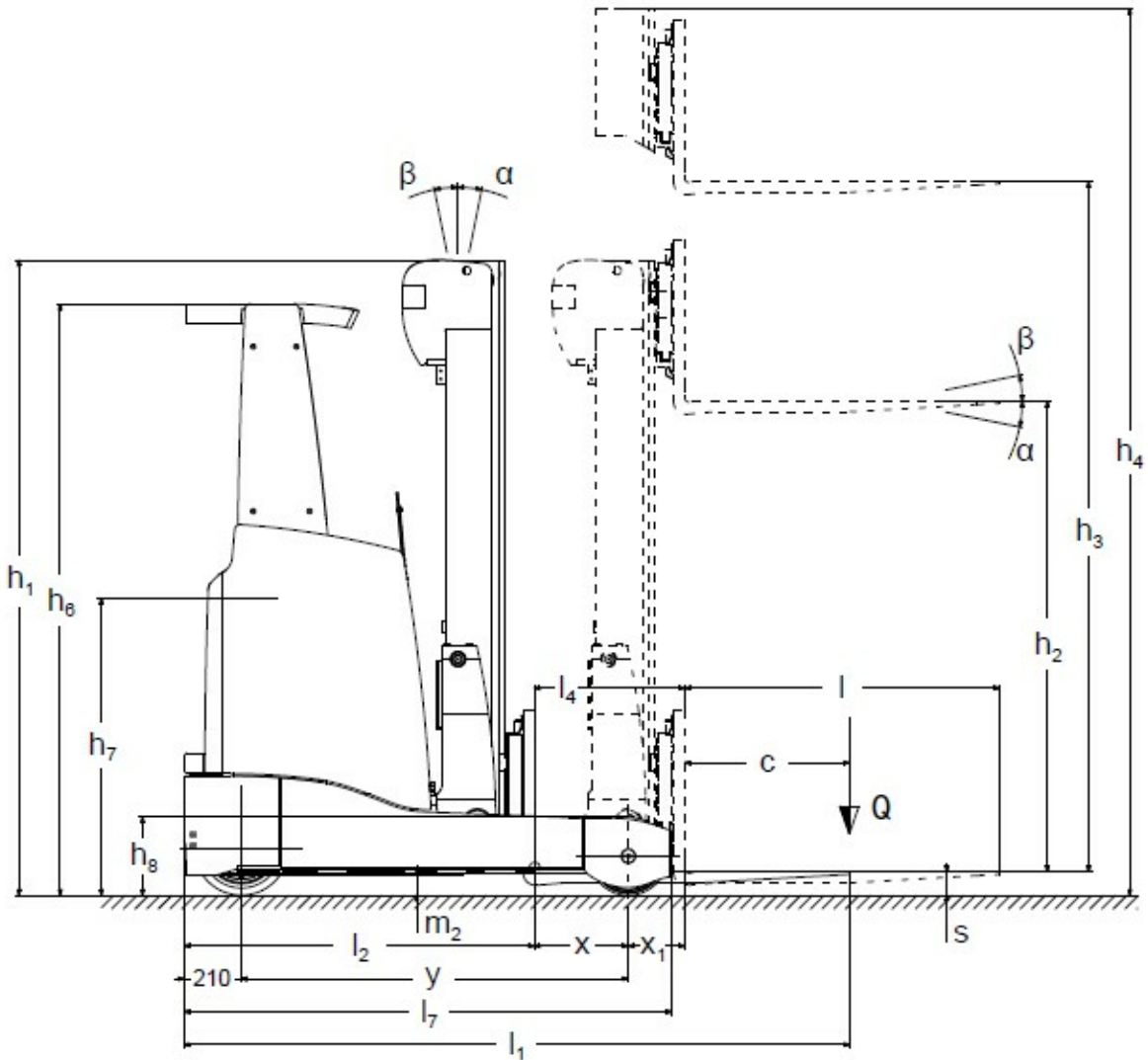

ETV MB 214/216

ETV MB 214, ETV MB 216	Lift (h3)	Retracted mast height (h1)	Free lift (h2)	Extended mast height (h4)	Forward/backward tilt of mast	Forward/backward tilt of fork carriage
Fork tilt / Triplex mast DZ / cold-formed	5000 mm	2200 mm	1548 mm	5652 mm		2 / 5 °
	5300 mm	2300 mm	1648 mm	5952 mm		2 / 5 °
	5900 mm	2500 mm	1848 mm	6552 mm		2 / 5 °
	6200 mm	2600 mm	1948 mm	6852 mm		2 / 5 °
	6500 mm	2700 mm	2048 mm	7152 mm		2 / 5 °
	6800 mm	2800 mm	2148 mm	7452 mm		2 / 5 °
	7100 mm	2900 mm	2248 mm	7752 mm		2 / 5 °
	7700 mm	3100 mm	2448 mm	8352 mm		2 / 5 °
	8420 mm	3340 mm	2688 mm	9072 mm		2 / 5 °
	9020 mm	3540 mm	2888 mm	9672 mm		2 / 5 °
Mast tilt / Triplex mast DZ / cold-formed	8420 mm	3340 mm	2688 mm	9072 mm	0.5 / 1 °	
	9020 mm	3540 mm	2888 mm	9672 mm	0.5 / 1 °	
Mast tilt / Triplex mast DZ / hot-rolled	5000 mm	2200 mm	1548 mm	5652 mm	1 / 5 °	
	5300 mm	2300 mm	1648 mm	5952 mm	1 / 5 °	
	5900 mm	2500 mm	1848 mm	6552 mm	1 / 3 °	
	6200 mm	2600 mm	1948 mm	6852 mm	1 / 3 °	
	6500 mm	2700 mm	2048 mm	7152 mm	0.5 / 2 °	
	6800 mm	2800 mm	2148 mm	7452 mm	0.5 / 2 °	
	7100 mm	2900 mm	2248 mm	7752 mm	0.5 / 2 °	
	7700 mm	3100 mm	2448 mm	8352 mm	0.5 / 1 °	
ETV MB 216	Lift (h3)	Retracted mast height (h1)	Free lift (h2)	Extended mast height (h4)	Forward/backward tilt of mast	Forward/backward tilt of fork carriage
Fork tilt / Triplex mast DZ / cold-formed	9110 mm	3670 mm	2930 mm	9850 mm		2 / 5 °
	9620 mm	3840 mm	3100 mm	10360 mm		2 / 5 °
	9950 mm	3950 mm	3210 mm	10690 mm		2 / 5 °
	10220 mm	4040 mm	3300 mm	10960 mm		2 / 5 °
	10520 mm	4140 mm	3400 mm	11260 mm		2 / 5 °
	10700 mm	4200 mm	3460 mm	11440 mm		2 / 5 °

VDI table

Stand-on: 01/2025

Characteristic	1.1	Manufacturer (abbreviated description)		Jungheinrich	
	1.2	Manufacturer's type designation		ETV MB	
	1.3	Drive		Electric	
	1.4	Operation		Sideways-seated	
	1.5	Load capacity/load	Q kg	1400	1600
	1.6	Load centre distance	c mm	600	
	1.8	Load distance, centre of drive axle to fork	x mm	345	395
	1.8.1	Load distance, centre of drive axle to fork, mast extended	mm	205	
	1.9	Wheelbase	y mm	1410	1460
Weights	2.1.1	Service weight (incl. battery)	kg	3004	3070
	2.3	Axle load unladen front/rear	kg	1814 / 1190	1885 / 1185
	2.4	Axle load fork forward laden front/rear	kg	567 / 3837	534 / 4136
	2.5	Axle load fork back laden front/rear	kg	1551 / 2853	1650 / 3020
Wheels/suspension system	3.1	Tyres		Polyurethane (PU)	
	3.2	Tyre size, front		Ø 343 x 114	
	3.3	Tyre size, rear		Ø 285 x 100	
	3.5	Wheels, number front/back (x=driven)		1x / 2	
	3.7	Tread width, rear	b11 mm	1136	
Basic dimensions	4.1	Forward/backward tilt of mast	a/β °	1 / 5	
	4.2	Retracted mast height (h1)	h1 mm	2300	
	4.3	Free lift (h2)	h2 mm	1800	
	4.4	Lift (h3)	h3 mm	5300	
	4.5	Extended mast height (h4)	h4 mm	5952	
	4.7	Height of overhead guard (cab)	h6 mm	2154	
	4.8	Seat height/stand height	h7 mm	1068	
	4.10	Height of support arms	h8 mm	285	
	4.19	total length	l1 mm	2425	
	4.20	Length including fork shank	l2 mm	1275	
	4.21.1	total width	b1 mm	1270	
	4.21.2	total width	b2 mm	1270	
	4.22	Fork dimensions	s/e/ l mm	40 x 120 x 1150	
	4.23	Fork carriage connection class		2B	
	4.24	Fork carriage width	b3 mm	800	
	4.25	Width across forks	b5 mm	335	
	4.26	Width between support arms/loading areas	b4 mm	940	
	4.28	Reach distance	mm	544	594
	4.32	Ground clearance centre of wheelbase	m2 mm	80	
	4.34.1	Aisle width (pallet 1000x1200 sideways)	Ast mm	2708	2722
	4.34.2	Aisle width (pallet 800x1200 length)	Ast mm	2764	2769
	4.35	Turning radius	Wa mm	1620	1670
	4.37	Length over the support arms	L7 mm	1780	1830
Performance data	5.1	Travel speed laden/unladen (Efficiency drivePLUS)	km/h	11 / 11 14 / 14	
	5.2	Lift speed laden/unladen (Efficiency liftPLUS)	m/s	0.36 / 0.7 0.51 / 0.7	0.34 / 0.7 0.48 / 0.7
	5.3	Lowering speed laden/unladen (Efficiency liftPLUS)	m/s	0.55 / 0.5 0.55 / 0.5	
	5.4	Reach speed laden/unladen (Efficiency liftPLUS)	m/s	0.2 / 0.2 0.2 / 0.2	
	5.7	Gradeability laden/unladen (Efficiency drivePLUS)	%	9 / 13 9 / 13	8 / 12 8 / 12
	5.8	Max. gradeability laden/unladen (Efficiency drivePLUS)	%	10 / 15 10 / 15	

	5.9	Acceleration time laden/unladen (Efficiency drivePLUS)	s	5.3 / 5 4.5 / 4.2	5.3 / 5 4.7 / 4.3
	5.10	Service brake		electric	
E-motor/Electronics	6.1	Drive motor, performance S2 60 min (Efficiency drivePLUS)	kW	6 8.5	
	6.2	Lift motor, performance with S3 (Efficiency liftPLUS)	kW	13.3 15.5	
	6.3	Battery according to DIN 43531/35/36		DIN 43531 C	
	6.4	Battery voltage/nominal capacity	V / Ah	48 / 465	
	6.5	Battery weight	kg	750	
	6.6.1	Energy consumption according to EN cycle (Efficiency PLUS)	kWh/h	2.41 2.89	2.72 3
	6.6.2	CO2 equivalent as per EN 16796 (Efficiency PLUS)	kg/h	1.3 1.6	1.5 1.6
	6.7	Throughput (Efficiency PLUS)	t/h	59 61	68 69
	6.8.1	Energy consumption with max. throughput (Efficiency PLUS)	kWh/h	2.66 3.47	2.77 3.83
Other	8.1	Type of drive control		Mosfet/AC	
	10.1	Operating pressure for attachment	bar	230	
	10.2	Oil flow for attachments	l/min	20	
	10.7	Sound level as per EN12053, operator's ear	dB (A)	70	

- This data sheet according to VDI guideline 2198 only states the technical values of the standard truck. Different tyres, other masts, additional equipment etc. may result in different values.

The German production facilities in
Norderstedt, Moosburg and Landsberg
are certified as well as our Genuine Parts
Center in Kaltenkirchen. ISO 9001
ISO 14001

Jungheinrich fork lift trucks meet
European safety requirements. 

**JUNGHEINRICH**